

# MSR120 Series

---

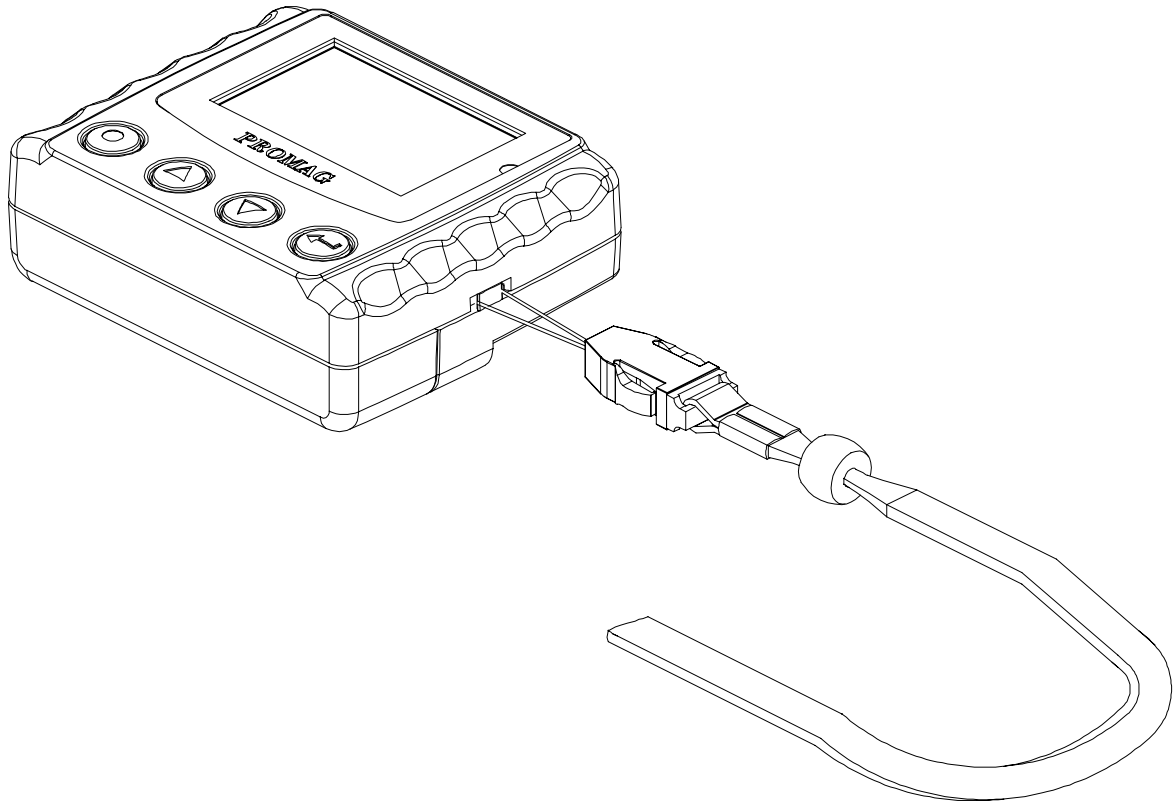

---

## Portable 3 Tracks Magnetic Card Reader with LCD User's Manual

Manual Part Number : TM951087 Rev 01

(Preliminary)

October 2004

REGISTERED TO ISO 9001:2000

8F, No.31, Lane 169, Kang-Ning St., Hsi-Chih Taipei Hsien, 221 Taiwan

Phone: (886) 2-2695-4214

FAX: (886) 2-2695-4213

[www.gigatms.com.tw](http://www.gigatms.com.tw)

**Copyright© 1998 - 2004**  
**GIGA-TMS INC.**  
**Printed in Taiwan**

Information in this document is subject to change without notice. No part of this document may be reproduced or transmitted in any form or by any means, electronic or mechanical, for any purpose, without the express written permission of GIGA-TMS Inc.

### **REVISIONS**

| <b>Rev Number</b> | <b>Date</b> | <b>Notes</b>    |
|-------------------|-------------|-----------------|
| 01                | 8 Oct 04    | Initial Release |

# Contents











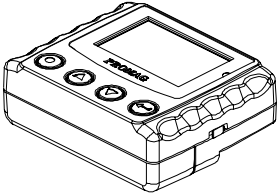
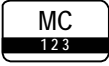
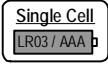

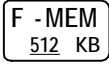

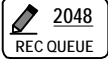
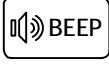

|  |       |    |
|--|-------|----|
| <b>Information</b>                           | ..... | 4  |
| <b>Technical And Operational Description</b> | ..... | 6  |
| <b>Connections</b>                           | ..... | 12 |
| <b>Card Data Format</b>                      | ..... | 14 |
| <b>Demo Software</b>                         | ..... | 15 |
| <b>Specifications</b>                        | ..... | 21 |
| <b>Communication Protocol</b>                | ..... | 22 |
| <b>USB Driver Setup</b>                      | ..... | 29 |

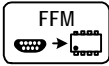
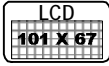
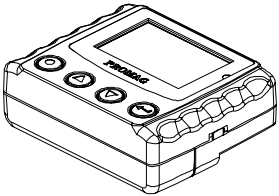
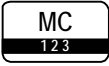
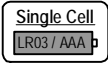
## FCC COMPLIANCE STATEMENT

This equipment has been tested and found to comply with the limits for a Class A digital device, pursuant to Part 15 of the FCC Rules. These limits are designed to provide reasonable protection against harmful interference when the equipment is operated in a commercial environment. This equipment generates, uses, and can radiate radio frequency energy and, if not installed and used in accordance with the instruction manual, may cause harmful interference to radio communication. Operation of this equipment in a residential area is likely to cause harmful interference in which case the user will be required to correct the interference at his own expense.

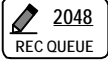
# Information

## MSR120 Series Magnetic Swipe Reader

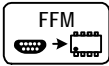
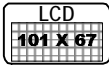
| MACHINE TYPE  | FUNCTION   |
|---|--|
|  <p><b>MSR120</b><br/>RS232 Interface</p>  |    <br>   <br>                        |
|  <p><b>MSR120U</b><br/>USB Interface</p> |    <br>   <br>    |

## Read the instructions on your device before installing batteries

1. Insert batteries into your device properly, with the (+) and (-) terminals aligned correctly.
2. Discharged batteries should be removed from equipment to prevent possible damage.
3. Store the batteries in a cool and dry place. [Batteries should be stored at temperatures between 50°F (10°C) and 77°F (25°C), with relative humidity not exceeding 65 percent. Refrigeration of alkaline batteries is not necessary because of their very good capacity retention. Excessive temperature cycling and storage at temperatures greater than 77°F (25°C) should be avoided to maximize shelf life.]
4. Remove batteries from the electrical device if the device is not going to be used for a long time.
5. Keep battery contact surfaces and battery compartment contacts clean by rubbing them with a clean pencil eraser or a rough cloth each time you replace batteries.
6. Keep batteries away from children. If swallowed, contact a physician at once.
7. Don't recharge a battery unless it is specifically marked "rechargeable". Attempts to recharge an alkaline battery may cause an imbalance within the cell, leading to gassing and possibly explosion on either charge or discharge cycles.
8. Don't dispose of batteries in a fire—they may rupture or leak.
9. Don't carry loose batteries in a pocket or purse with metal objects like coins, paper clips, etc. This will short-circuit the battery, generating high heat.

## ■ Standard Package

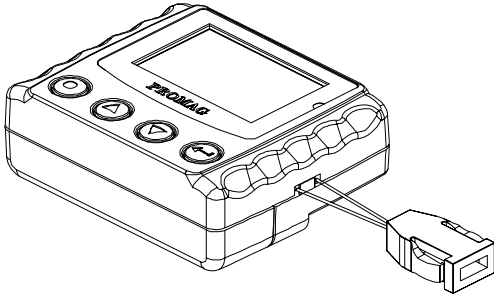

**Main unit  
( MSR120 )**

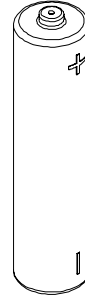

**LR03-AAA ALKALINE 1.5V Battery  
( BAT-T0010 )**

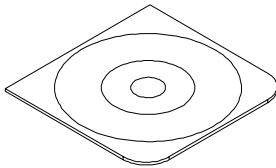

**CD-ROM  
( DISK5216 )**

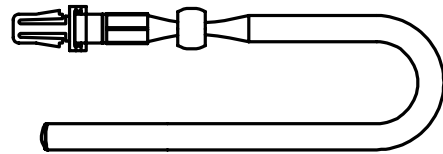

**Chain Sling  
( TM09F1001 )**

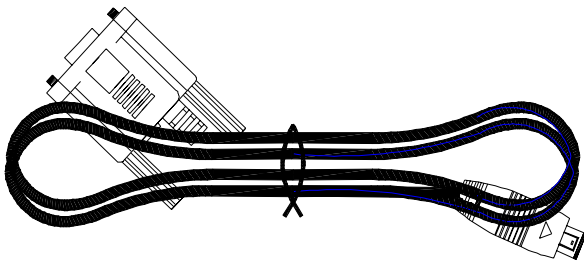

**RS232 Cable for MSR120 series  
( WAS-T0017 )**

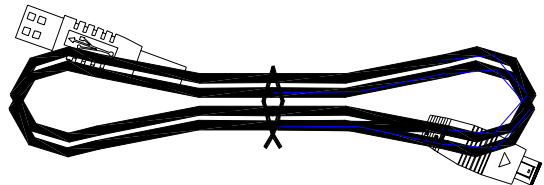

**USB Cable for MSR120U series  
( WAS-1571 )**

# Technical And Operational Description

## Front Panel and Operations

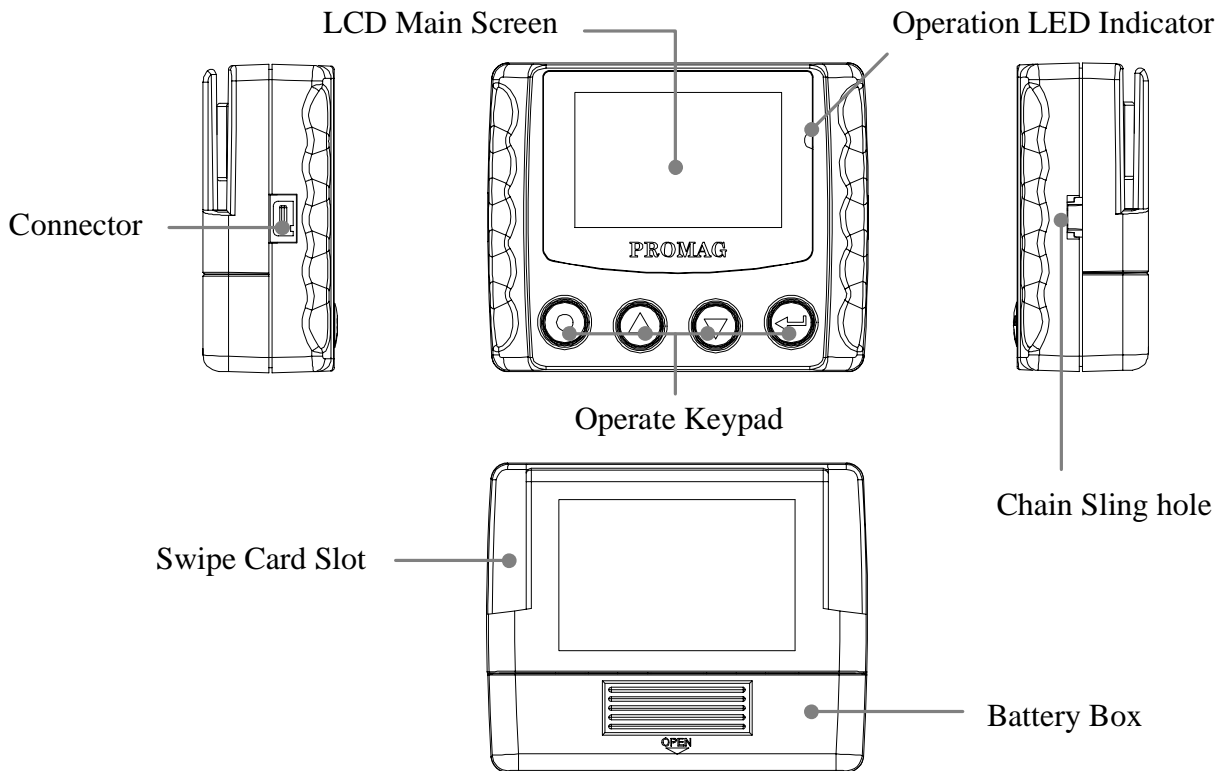

- **Swipe Card Slot**  
Swipe the card through the entire length of the slot to read.
- **Operation LED Indicator**  
When encountering erroneous input, defective card, misread, bad memory or incorrectly encoded data and so on, the device will turn on the ERROR indicator .
- **LCD Main Screen**  
Indicating the battery is ready ,charging progress , charge done, charge suspend in charge mode or low battery in operational mode.
- **Connector**  
For connection to host computer and external Power .
- **Battery Box**  
Put the battery in box and hold battery .
- **Operate Keypad**  
Turn the MSR120 on/off power and Operate.
- **Chain Sling Hole**  
Connect to chain sling.

## ■ LCD Display

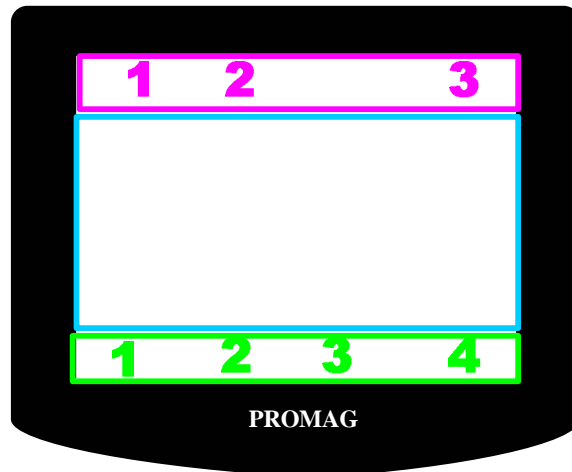



Status Function Area

Main Display Area



Keypad Guidance Area

### ● Status Function Area

#### 1. Power Status

-  Battery Power Supply
-  Low Battery Power Supply
-  External Power Supply

#### 2. Decode Status

-  Track 1 be Decoded
-  Track 2 be Decoded
-  Track 3 be Decoded

#### 3. Guidance Number

- 000003 Current Record Number of Display or Store
- 2 Main Menu Item
- 2-1 Sub-Menu Item

### ● Main Display Area

Display Date & Week & Time , Menu Item , Record Data , Parameter Setting , Other Information

### ● Keypad Guidance Area

1. Corresponding Key - 

Power /Exit / Back / Cancel / No Key Function
2. Corresponding Key - 

Up / Up scroll / Increase Key Function
3. Corresponding Key - 

Down / Down scroll / Decrease Key Function
4. Corresponding Key - 

Menu / Enter / Save / Next / Yes Key Function

## ■ Function Menu

|                       |   |  |
|-----------------------|---|--|
| <b>1. Profiles</b>    | <b>1-1. Machine ID</b>  | Display Machine ID -<br>2 Character  |
|                       | <b>1-2. User Name</b>   | Display User Name -<br>16 Character  |
|                       | <b>1-3. Display Format</b>                                      | Set Display Mode -<br>Track Series<br>Track Parallel<br>Credit Card  |
| <b>2. Setting</b>     | <b>2-1. BackLight</b>   | Set Back Light Duration -<br>00 ~ 255 Second   |
|                       | <b>2-2. Auto Power Off</b>                                      | Set Auto Power Off Duration -<br>00 ~ 255 Second   |
|                       | <b>2-3. Power Mode</b>  | Set Power Mode -<br>Switch Mode<br>Auto Power Off Mode   |
|                       | <b>2-4. Sound</b>   | Set Operate Sound -<br>ON<br>OFF   |
|                       | <b>2-5. Reset</b>   | Reset Default -<br>BackLight = 15 second<br>Auto Power Off = 30 second<br>Power Mode = Switch Mode<br>Sound = ON |
| <b>3. Database</b>    | <b>3-1. Status</b>  | Display Memory Status -<br>Used Space, Unused Space, Total Space   |
|                       | <b>3-2. View</b>  | Display all records in memory  |
| <b>4. Calendar</b>    | <b>4-1. Date Format</b>   | Set Date Format Select -<br>Year / Month / Date<br>Date / Month / Year<br>Month / Date / Year                    |
|                       | <b>4-2. Set Date/Time</b>                                       | Set Date -<br>Year, Month, Date<br>Set Time -<br>Week, Hour, Minute, Second                                      |
| <b>5. Information</b> | <b>5-1. Product Name, Product Description, Firmware Version</b> |  |



## ■ Display Information

### Exceptional Indicator

| LCD Display message       | Description   | Counterplot                         |
|---------------------------|---|-------------------------------------|
| <b>Check RTC !</b>        | The RTC is malfunctioning<br>( After swipe card )                     | Setting Date and Time               |
| <b>FLASH Full !</b>       | The record already is full.<br>( After swipe card )                   | Download Record<br>and Erase Record |
| <b>Check FLASH !</b>      | The record can't write into the FLASH memory.<br>( After swipe card ) | Connect Agent                       |
| <b>Decode Error !</b>     | Swipe Card can't decode.<br>( After swipe card )                      | Swipe Card again<br>or Change Card  |
| <b>No Record !</b>        | No Record in FLASH memory.<br>( Enter Database -View function )       | Swipe Card                          |
| <b>Recode not empty !</b> | The FLASH memory not empty.<br>( Enter Calendar function )            | Download Record<br>and Erase Record |
| <b>ISP MODE</b>           | Enter FMM Mode<br>( By communication command )                        | Update New Firmware                 |

### LED Indicator

| Status                          | Green LED                   | Red LED                  | Buzzer                   | Read Card |
|---------------------------------|-----------------------------|--------------------------|--------------------------|-----------|
| <b>Power On</b>                 | Take turns blink<br>2 times |                          | <b>Beep. Beep.</b>       | <b>X</b>  |
| <b>Auto Power Off</b>           | Take turns blink<br>2 times |                          | <b>Beep. Beep.</b>       | <b>X</b>  |
| <b>Ready</b>                    | <b>Off</b>                  | <b>Off</b>               | <b>X</b>                 | <b>O</b>  |
| <b>Read OK</b>                  | <b>Blink<br/>1 times</b>    | <b>Off</b>               | <b>Beep.</b>             | <b>X</b>  |
| <b>Read Error</b>               | <b>Off</b>                  | <b>Blink<br/>1 times</b> | <b>Beep. Beep. Beep.</b> | <b>X</b>  |
| <b>Firmware Management mode</b> | <b>Off</b>                  | <b>On</b>                | <b>X</b>                 | <b>X</b>  |

## ■ Operational Description

### 1. Powered by Battery

For normal use, the unit is powered by battery. Push the Power Switch Button “⊕” for about 2 seconds to turn on the unit. Also push the Power Switch Button “⊖” for about 2 seconds to turn off the unit at Switch Mode. After the unit is turned on, the power would be turned off automatically if there is no swiping a card on the unit in 30 seconds (default) at Auto Power Off Mode. This means the unit would be turned off if no swiping a card again in every 30 seconds (default) after every card swiping. It would have Low Battery Detect/Warning indication when the unit is powered by battery.

### 2. Powered by Cable

When MSR120 is connected/disconnected to external power adapter by the WAS-T0017 RS232 cable or USB port by the WAS-1571 USB cable,, it would be turned On/Off automatically. When the unit is connected with the PC through the communication Cable (WAS-T0017 or WAS-1571) and the PC is running MSR120 software and then the unit will be turned on. Then you can do the unit Setting, Configuration or data downloading. When powered by cable from PC, the Power Switch “⊕” would have no function and the unit would have no Low Battery Detect/Warning function.

### 3. Real Time Clock Setting

Before start using the unit, you must set the Real Time Clock (RTC) inside the unit to your local time. If there is no battery for quite a while or it is powered by cable for quite a while this would cause Real Time clock (RTC) malfunctioned due to no power supply. When put on the battery to turn on the unit and the Red/Green LED take turns blinking, this means the RTC is malfunctioning and you must do the RTC time setting before you use the unit.

### 4. Low Battery Detect

When powered by battery, it would have Low Battery Detect function. When the battery goes low, the LCD would display “” and you must charge battery immediately, otherwise, the unit would shut down any time without pre-warning.

### 5. Swipe Card

When MSR120 is showing the status of any function on the screen, after swiping magnetic card to MSR120 reader, MSR120 is display magnetic card ID and record(s) information on the screen immediately. When MSR120 in not work for next magnetic card swipe, MSR120 reader will back to default screen automatically.

### 6. Operate for Calendar

Before setting calendar function, please delete remaining records from MSR120 reader, if there are records in the memory of MSR120, your operate setting for Calendar, MSR120 reader will display ”Record no empty” on the screen.

### 7. Memory Full Warning

Log database memory is full. You not be able to add any new records. Free the log database memory by uploading the data to the PC.

### 8. Communication by WAS-T0017

You must use external power when the PC connect to MSR120 by WAS-T0017 cable, or else the communication is not action. You should be press any key on MSR120 until the communication is finished, if you don't use external power.

### 9. Firmware Management mode (FMM)

FMM allows you to quickly upgrade your MSR120's internal firmware via com port and also check validity of currently loaded firmware. Contact your dealer for most recent firmware upgrade files.

### 10. Database in memory

The MSR120 allows you to manage database by software . The Logical Erase Database will logic clean the database. The Physical Erase Database will physical clean the database and it's can't recover the database. The Recovery Database will recover the previous erase and not yet covered database. The record pointer has retune to the top of the database after any erase.

## ■ Replace Battery

**Note:**

1. Read the instructions on your device before replace new battery.
2. MSR120 can used Single-cell alkaline, nickel-cadmium (NiCd), or nickel-metal hydride (NiMH) Battery

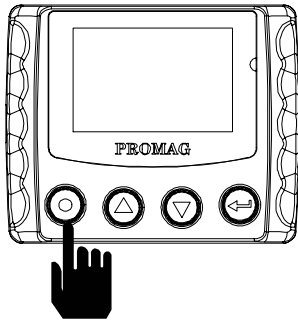

**1. Power turn off**



**4. Take new battery**

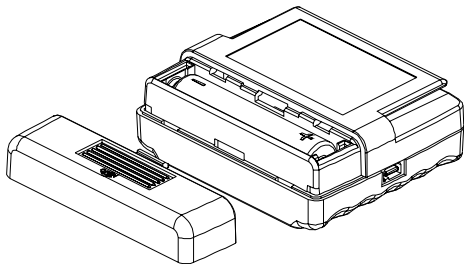

**2. Take the cover away**

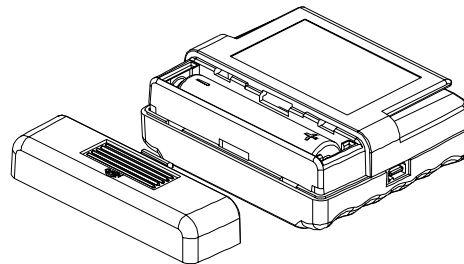

**5. Put new battery in**

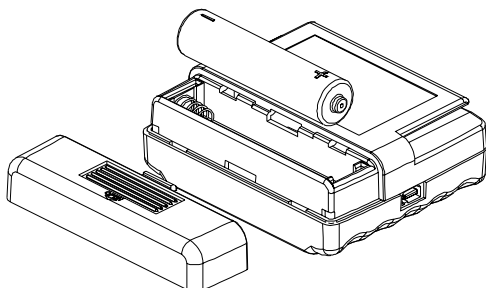

**3. Take the battery away**

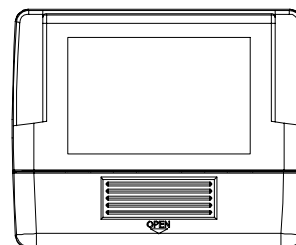

**6. Fix the battery cover**

# Connections

## WAS-T0017



| DSUB 9P POWER JACK | DSUB 9P FEMALE PIN | FUNCTION | MINI USB 4P |
|--------------------|--------------------|----------|-------------|
| +                  |                    | VCC      | 1           |
|                    | 2                  | TXD      | 2           |
|                    | 3                  | RXD      | 3           |
| -                  | 5                  | GND      | 4           |

No use

## Connect to PC

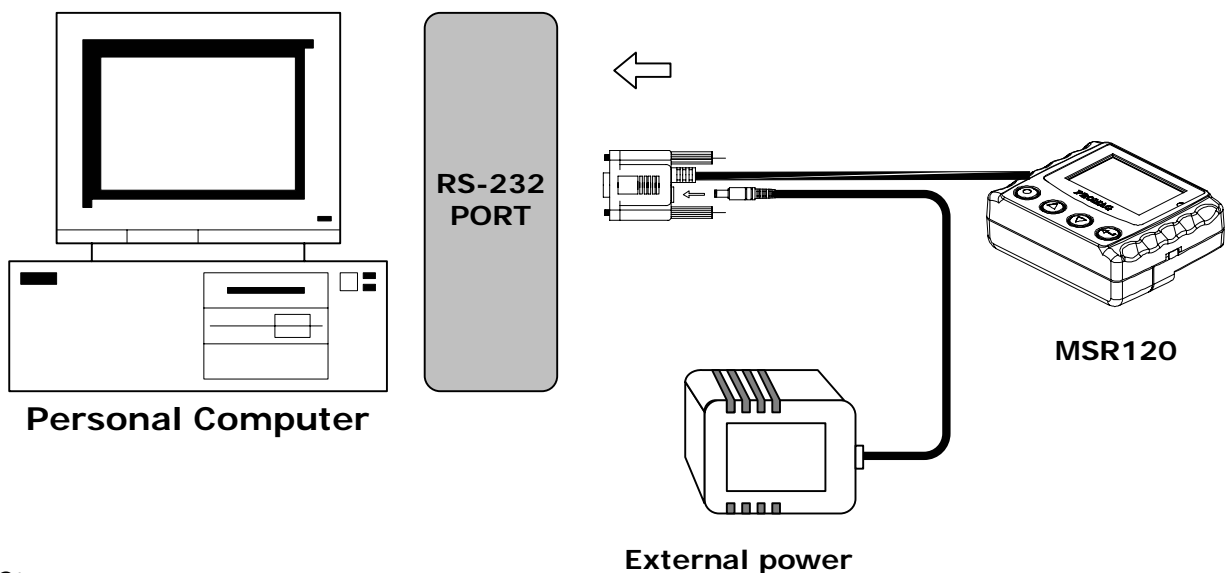

### Note:

1. When MSR120 is connected/disconnected with external power adapter, it would be turned On/Off automatically.
2. When MSR120 is not connected with external power adaptor, the corresponding key for power on MSR120 needs to be pressed all the time during the communications with the PC.

## WAS-1571



| USB 4P FEMALE PIN | FUNCTION |
|-------------------|----------|
| 1                 | VCC      |
| 3                 | D -      |
| 2                 | D +      |
| 4                 | GND      |

| MINI USB 4P | FUNCTION |
|-------------|----------|
| 1           | VCC      |
| 2           | RXD      |
| 3           | TXD      |
| 4           | GND      |

## Connect to PC

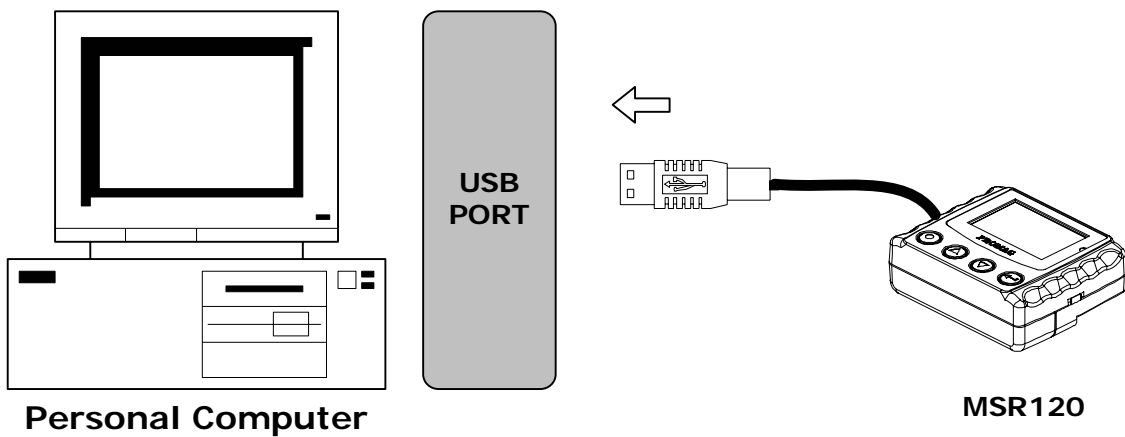

**Note:**

1. When MSR120 is connected/disconnected with USB port, it would be turned On/Off automatically.

# Card Data Format

## CARD DATA STRING

| TRACK 1 |    |             |    | TRACK 2 |    |             |    | TRACK 3 |    |             |    | DATE & TIME & WEEK |      |    |      |    |      |
|---------|----|-------------|----|---------|----|-------------|----|---------|----|-------------|----|--------------------|------|----|------|----|------|
| M1      | SS | TRACK1 DATA | ES | M2      | SS | TRACK2 DATA | ES | M3      | SS | TRACK3 DATA | ES | M4                 | DATE | SP | TIME | SP | WEEK |
| 01      | %  | TRACK1 DATA | ?  | 02      | ;  | TRACK2 DATA | ?  | 03      | +  | TRACK3 DATA | ?  | FE                 | DATE |    | TIME |    | WEEK |

## TRACK 1

|     |   |         |   |
|-----|---|---------|---|
| 01h | % | CARD ID | ? |
|-----|---|---------|---|

1. 01h is the physical track 1
2. SS is the start sentinel ( % ).
3. ES is the end sentinel ( ? ).
4. Card Id up to 76 alphanumeric data characters.

| Track 1 IATA            |     |
|-------------------------|-----|
| Bits Per Inch           | 210 |
| Bits Per Character      | 7   |
| Alphanumeric Characters | 79  |

## TRACK 2

|     |   |         |   |
|-----|---|---------|---|
| 02h | ; | CARD ID | ? |
|-----|---|---------|---|

1. 02h is the physical track 2
2. SS is the start sentinel ( ; ).
3. ES is the end sentinel ( ? ).
4. Card Id up to 37 numeric data characters.

| Track 2 ABA        |    |
|--------------------|----|
| Bits Per Inch      | 75 |
| Bits Per Character | 5  |
| Numeric Characters | 40 |

## TRACK 3

|     |   |         |   |
|-----|---|---------|---|
| 03h | + | CARD ID | ? |
|-----|---|---------|---|

1. 03h is the physical track 3
2. SS is the start sentinel ( + ).
3. ES is the end sentinel ( ? ).
4. Card Id up to 104 numeric data characters.

| Track 3 Thrift     |     |
|--------------------|-----|
| Bits Per Inch      | 210 |
| Bits Per Character | 5   |
| Numeric Characters | 107 |

## DATE&TIME&WEEK

| M4  | DATE       | SP | TIME     | SP | WEEK |
|-----|------------|----|----------|----|------|
| FEh | YYYY/MM/DD | SP | HH:MM:SS | SP | W    |
| FEh | MM/DD/YYYY | SP | HH:MM:SS | SP | W    |
| FEh | DD/MM/YYYY | SP | HH:MM:SS | SP | W    |

| WEEK |   |
|------|---|
| SUN  | 0 |
| MON  | 1 |
| TUE  | 2 |
| WED  | 3 |
| THU  | 4 |
| FRI  | 5 |
| SAT  | 6 |

1. FEh is the Separate Character.
2. Date have 3 formats - YYYY/MM/DD, MM/DD/YYYY, DD/MM/YYYY
3. SP is the SPACE characters ( 20h ).
4. TIME is 24hr .

# Demo Software

## STEP 1 : RUN MSR120 DEMO



## STEP 2 : CHOOSE COM PORT (Do not choose TCP/IP)

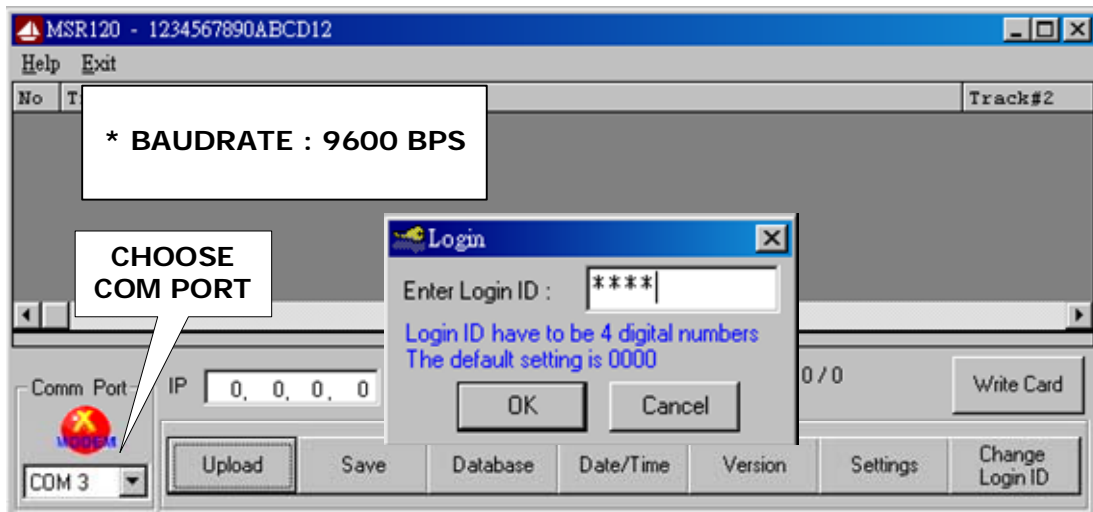

## STEP 3 : ENTER DATE/TIME TO GET DATE/TIME ( TO SHOW THE DATE&TIME IN MSR120 WHEN NEEDED)

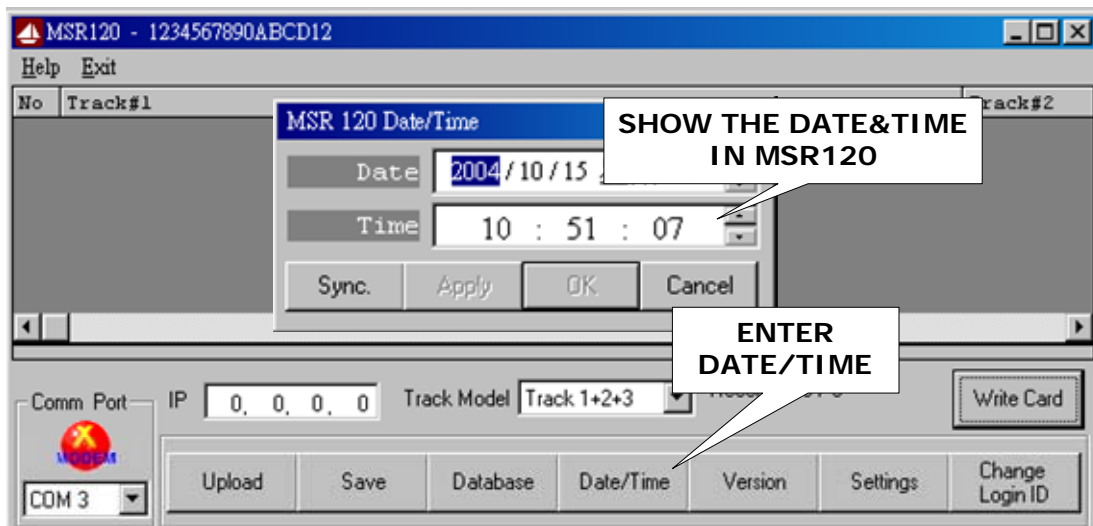

**STEP 4 : ENTER DATE/TIME TO SET DATE/TIME ( WHEN NEEDED)**  
**NOTE: MAKE SURE YOUR PC CURRENT TIME IS CORRECT BEFORE YOU SET PC TIME TO MSR120.**

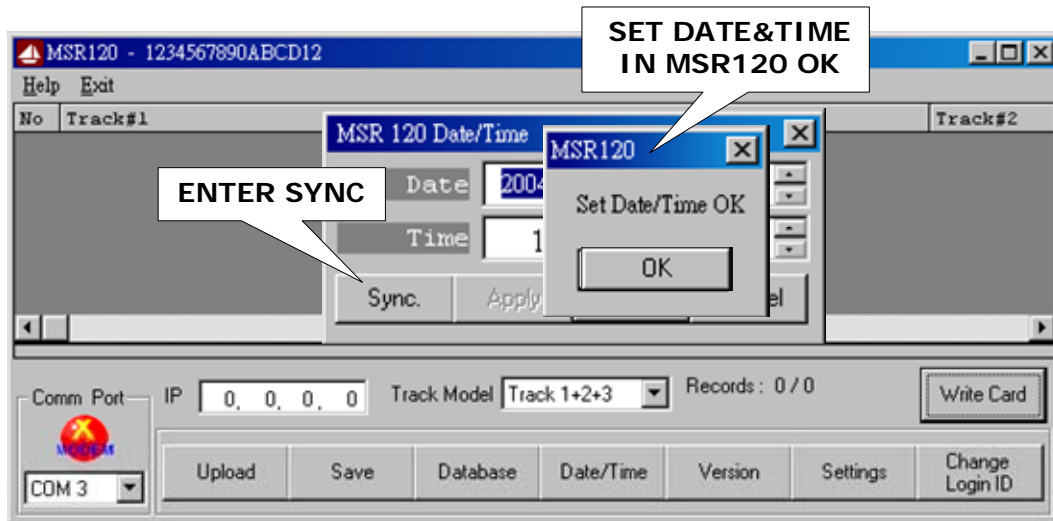

**STEP 5 : ENTER GET VERSION ( TO SHOW MSR120 FIRMWARE VERSION WHEN NEEDED)**

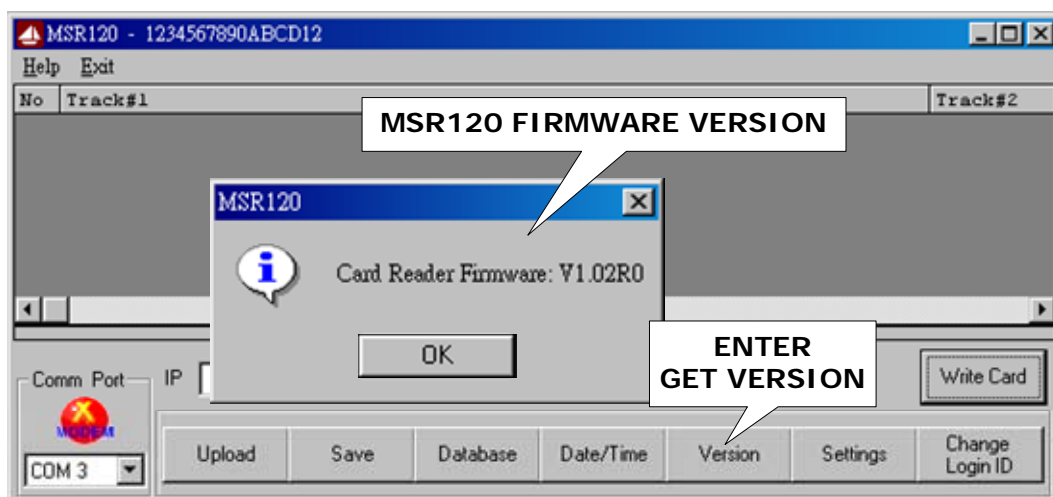

**STEP 6 : ENTER SETTING MSR120 PARAMETER.**

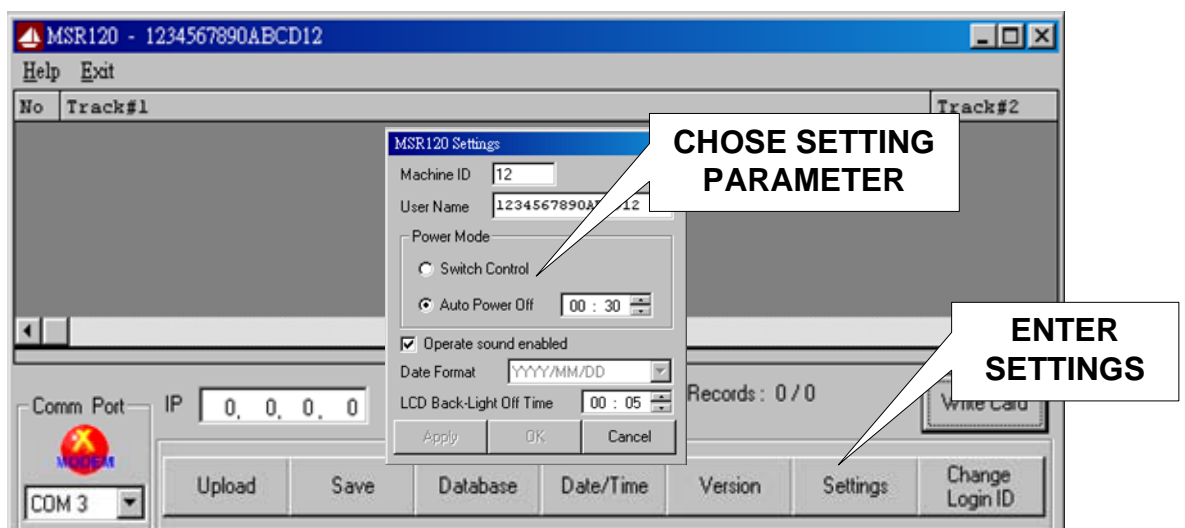



**STEP 7 : ENTER Change Login ID TO Change Login ID  
(Login ID default setting is "0000".)**

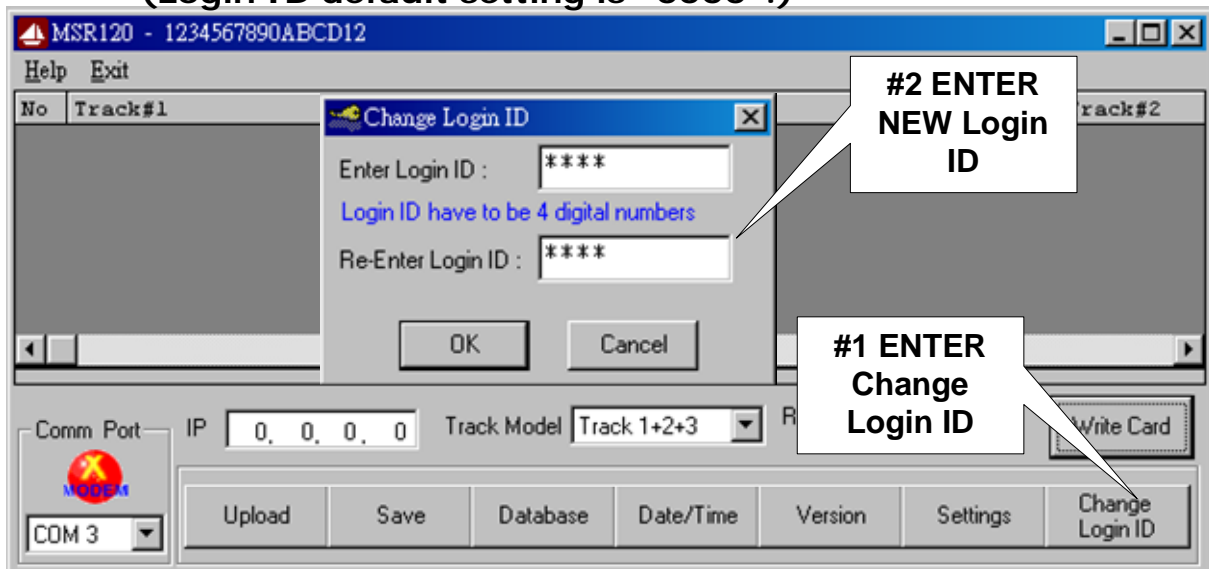

**STEP 8 : ENTER UPLOAD TO UPLOAD DATA**

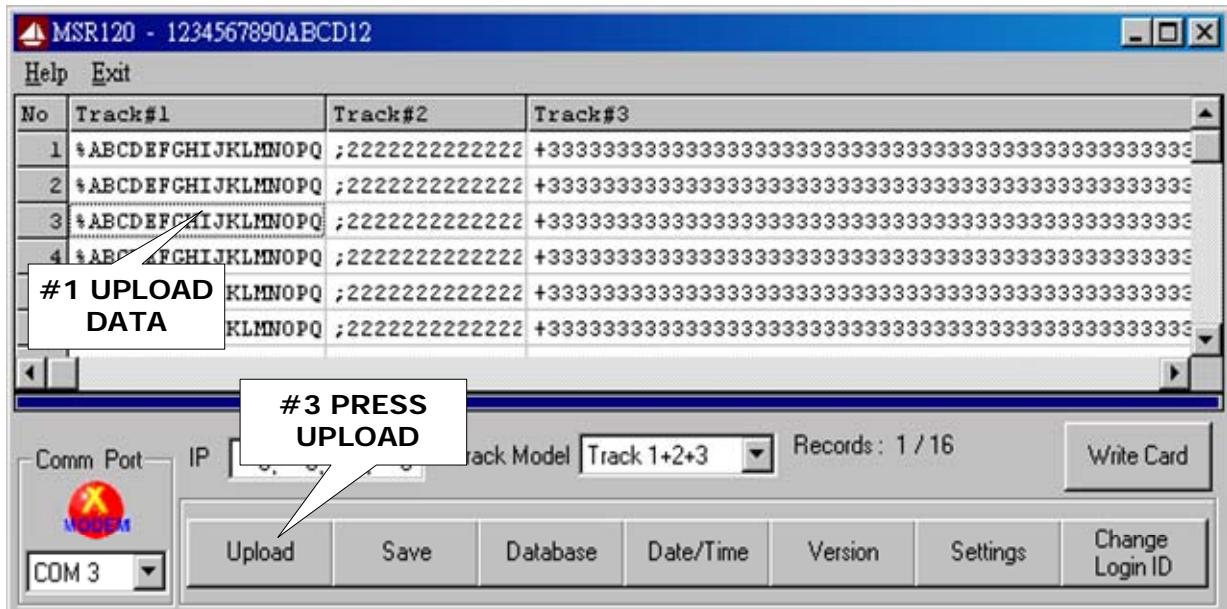

**STEP 9 : ENTER SAVE TO SAVE DATA**

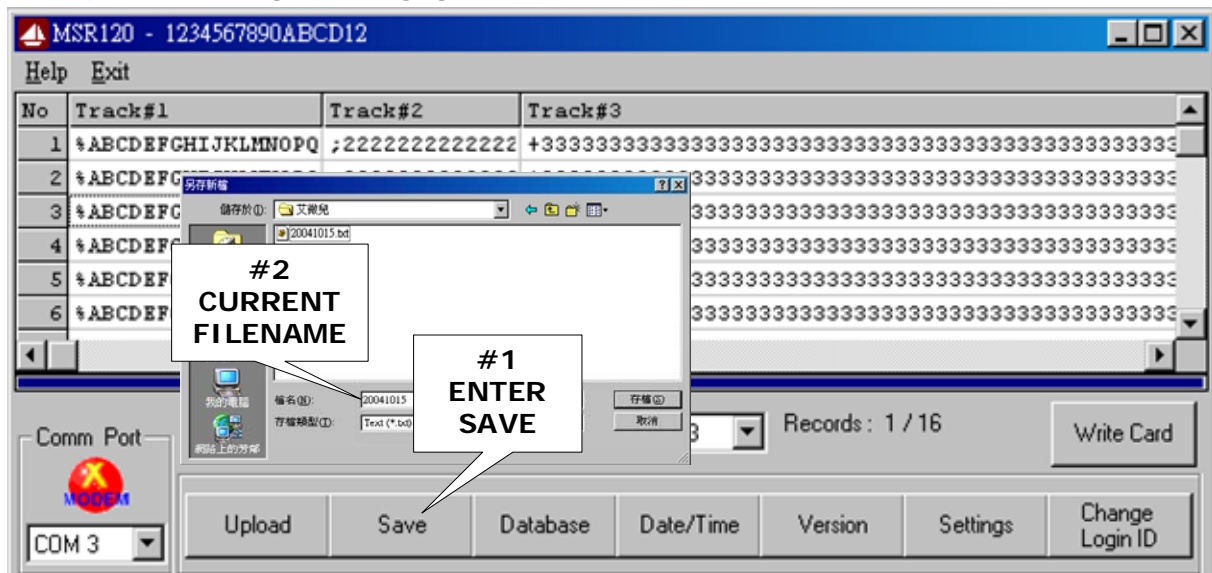

### STEP 10 : ENTER Write Card

Write Card function only supply to MSR206

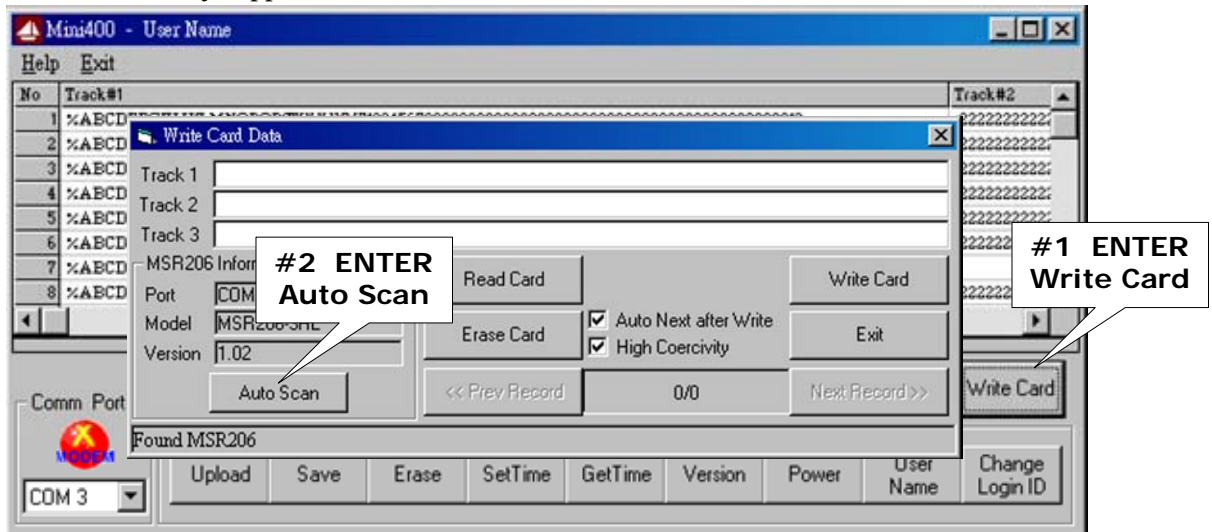

#### Write Card - Step 1: Select the data

Click [Prev Record] and [Next Record] to select the data from upload data. All three tracks data can be edited by user if necessary.

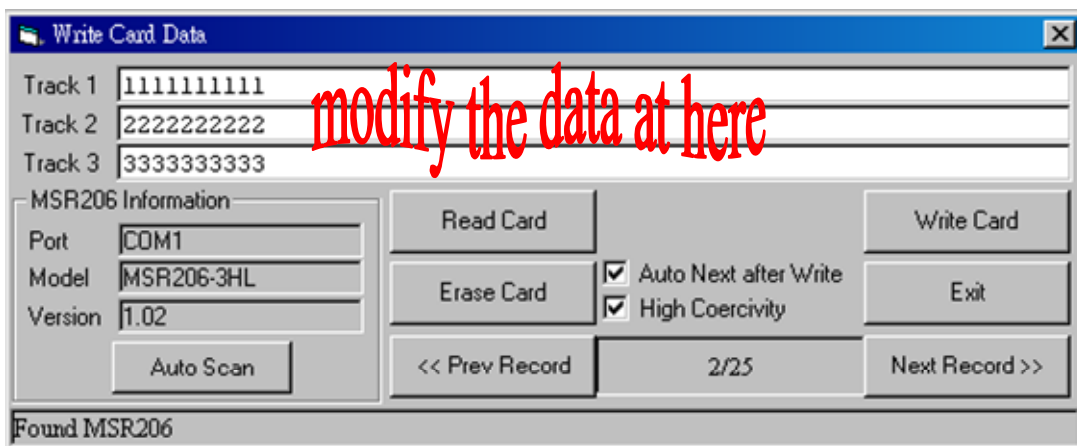

#### Write Card - Step 2: Select High/Low coercivity

Write Hi-Co card - Check the Hi-Co box; Write Lo-Co card - Uncheck the Hi-Co box.

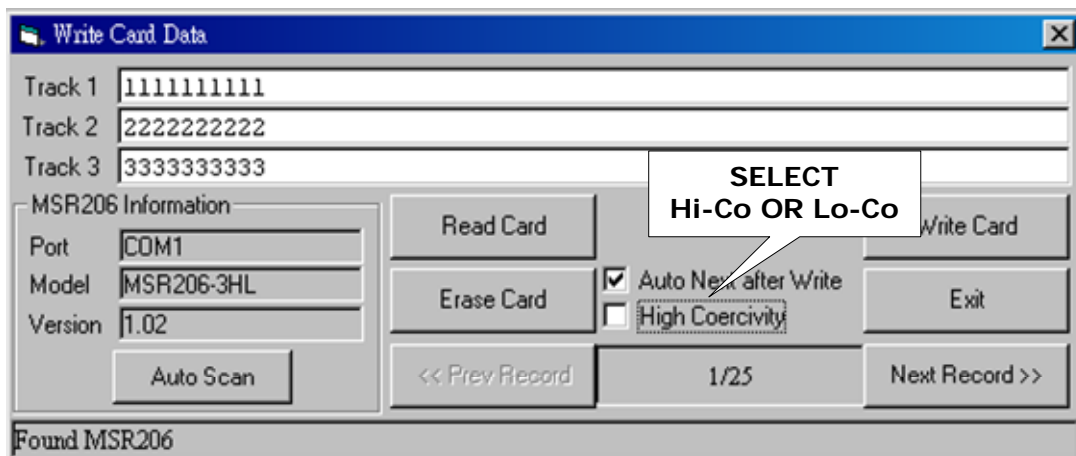

**Write Card - Step 3: Select Auto Next after Write**

The default setting of the [Auto Next after Write] check box is checked. User can click [Prev Record] or [Next Record] to select data that you need. Also, it allows user to uncheck [Auto Next] after write then select your own data.

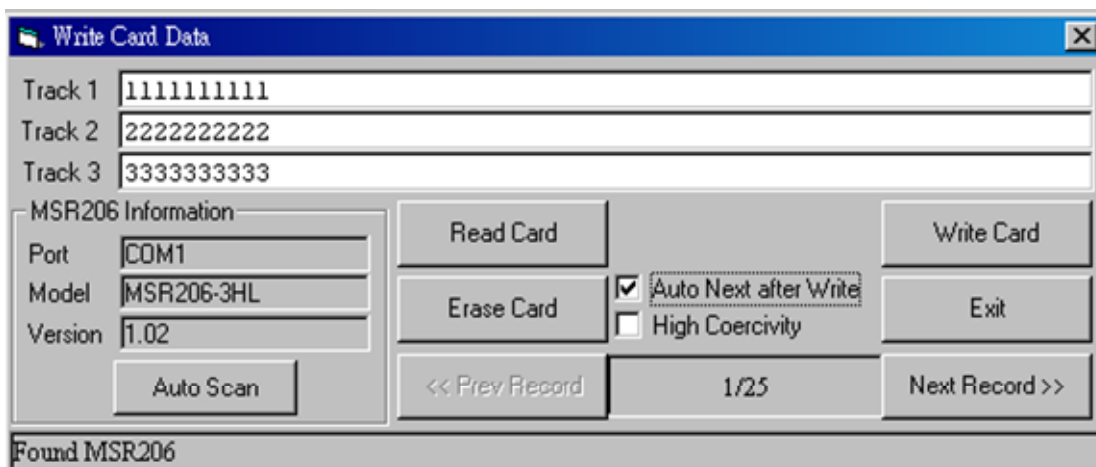
**Write Card - Step 4: Click [Write Card]**

Click [Write Card] button to write card. Click [Cancel] to stop write card function.

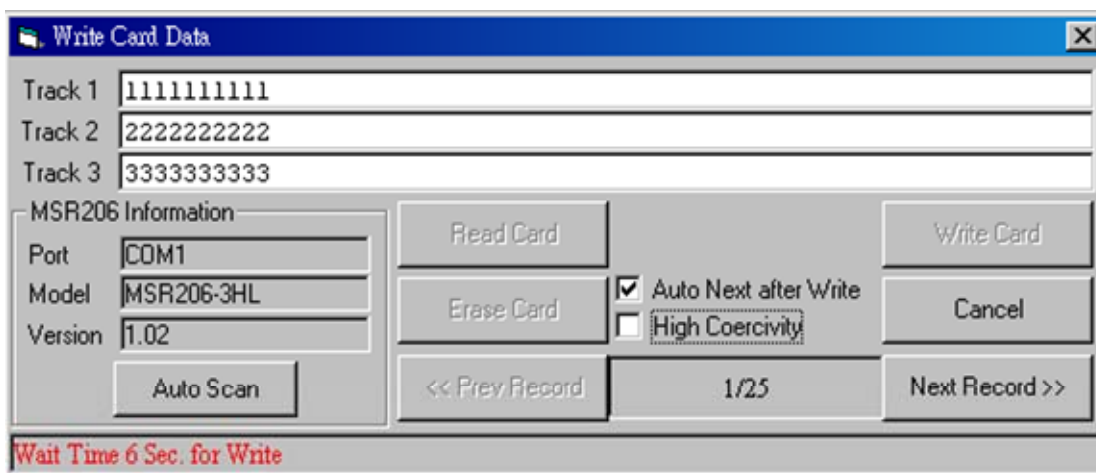
**Write Card - Step 5: Finish Write Card**

Swipe card, If the message is "Write OK", the card has been written successfully. If the message is "Write Error", Please make sure that you have selected right card type Hi-Co or Lo-Co.

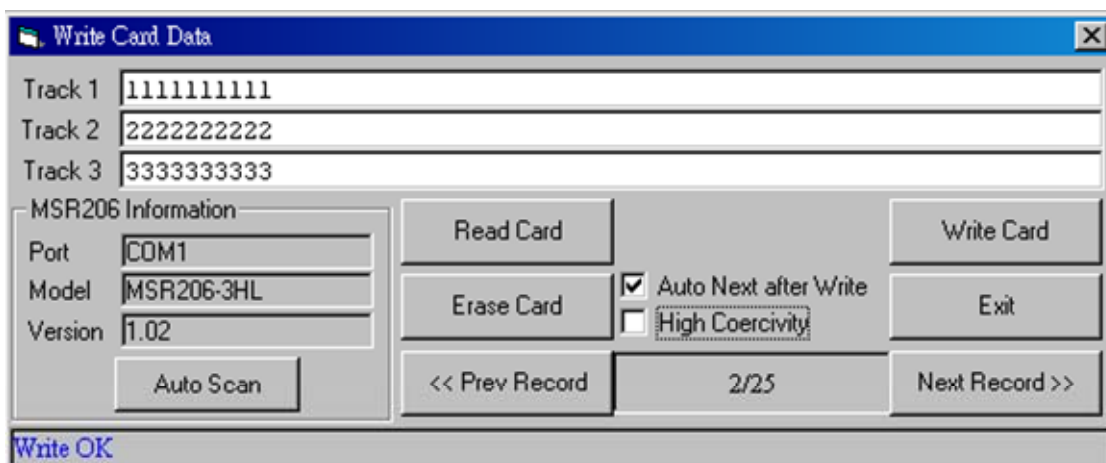

**STEP 12 : ENTER Database to erase the memory records of MSR120  
(Note : Always [Save] the data before [Erase])**

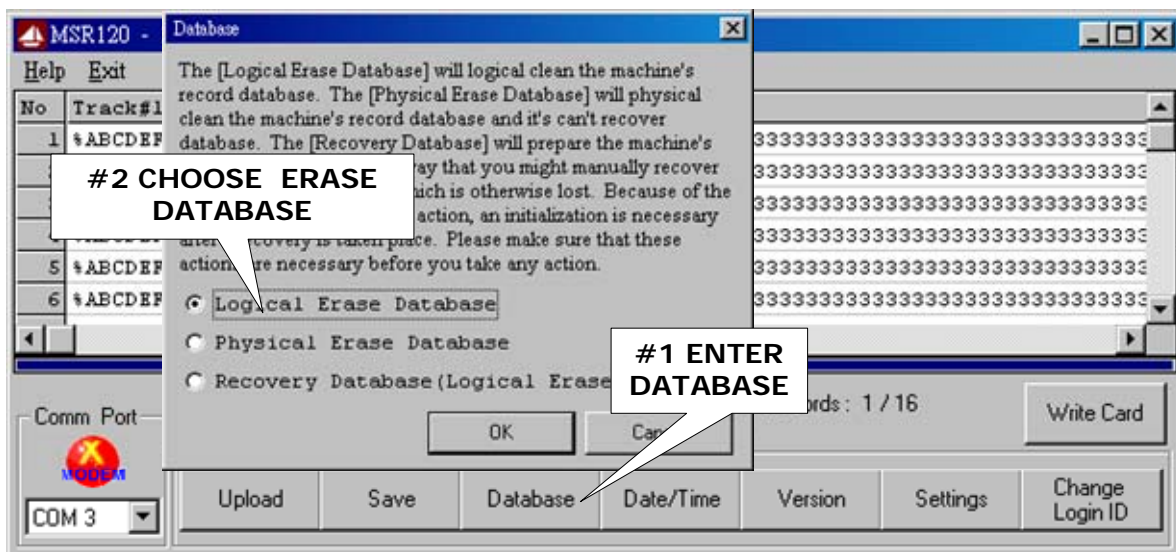

**STEP 13 : ENTER Database to recovery the memory records of MSR120  
(Note : Database must empty)**

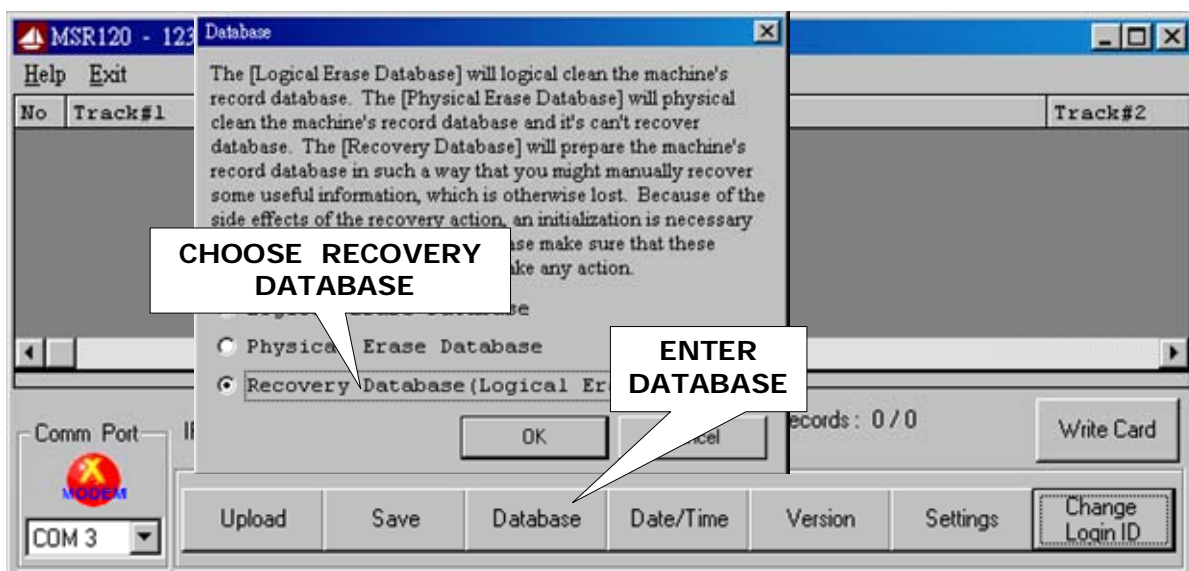

**STEP 14 : EXIT MSR120 SOFTWARE**

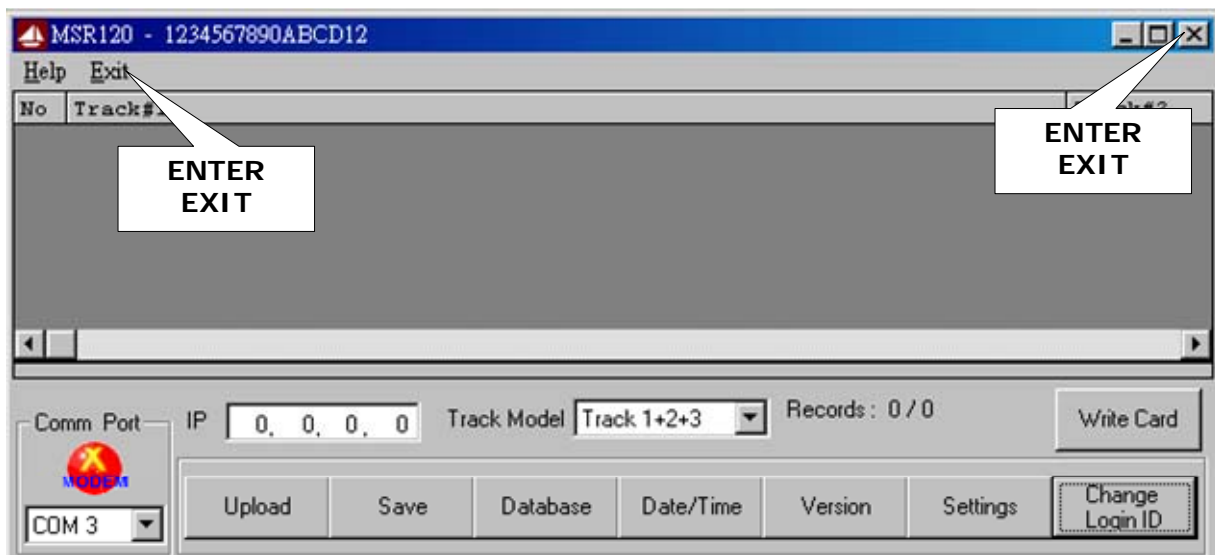

# Specifications



## Magnetic Stripe Card

TRACK 1 / IATA / 210 bpi / 79 Alphanumeric Characters  
TRACK 2 / ABA / 75 bpi / 40 Numeric Characters  
TRACK 3 / Thrift / 210 bpi / 107 Numeric Characters



## RS232 Interface

RS232 , Half-Duplex , 8N1 , 9600 bps



## USB Interface

Full compliance with the USB Specification V 1.1  
The device uses a Virtual Serial Port Driver, making it appear to have the software like a standard RS232 Serial Port.

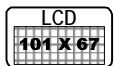

## LCD Display

LCD type : FSTN  
Dot arrangement : 101 x 67 Dots Matrix LCD Module  
Viewing direction : 6 O'clock



## Communication Protocol :

Version 1.2 (GNET V1.2)



## CLOCK

Real Time Clock (RTC) module and back-up capacitor



## Memory Size for Storing Data

CMOS Serial Flash Memory 512K bytes  
Up to 2048 records ( 256 Bytes / Record )

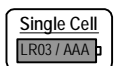

## Battery Power

Single-cell alkaline, nickel-cadmium (NiCd), or nickel-metal hydride (NiMH) battery .



## Power Supply from Cable

DC 5V , 200mA ( for RS-232 ) or USB Powered

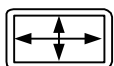

## Dimensions

L 58 x W 20 x H 47 mm

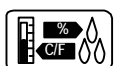

## Environment

Operating Temp : -0 ~ +55°C  
Storage Temp : -10 ~ +60°C  
Humidity : 10 ~ 90 % relative

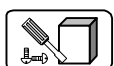

## Mounting

Portable or Any surface

# Communication Protocol

## GNET FEATURES

- Support TTY (TELE TYPE) OPERATION -  
Use TTY to send commands and messages.
- Simple handshaking -  
One enquiry one answer back.
- Multi-link capability
- Expandability -  
GNET provides 4 major functions:
  1. POLLING
  2. LOGIN / LOGOUT
  3. DATABASE
  4. INFORMATION
 Also can be expandable.
- Simple format  
Use ASCII value for each field and use Separator "," between two Fields.



## GNET Handshaking

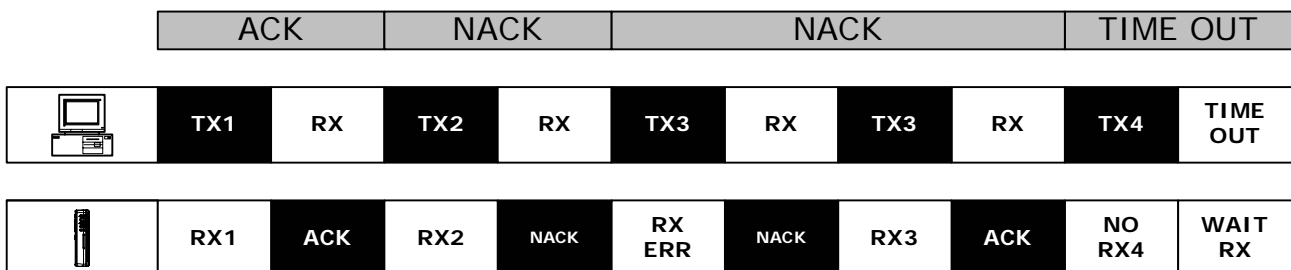

## GNET PACKET

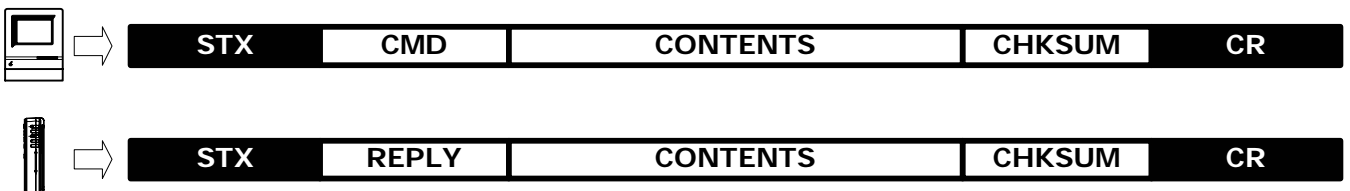

| ITEM     | Dec     | Hex     | Control Key | Function               |
|----------|---------|---------|-------------|------------------------|
| STX      | 2       | 02      | ^B          | Start of Text          |
| CMD      | Ascii   | Ascii   | Ascii       | Command Code           |
| CONTENTS | Ascii   | Ascii   | Ascii       | Contents Data          |
| CHKSUM   | Ascii   | Ascii   | Ascii       | Check Sum              |
| CR       | 13      | 0d      | ^M          | Carriage Return        |
| REPLY    | (78) 65 | (4e) 41 | (N) A       | (Negative) Acknowledge |

**Command Index Table**

| Topic    | Command | Contents       | Description            |
|----------|---------|----------------|------------------------|
| SETTING  | F       | -              | Get Product Version    |
|          | S       | Date,Time,Week | Set Date,Time and Week |
|          | T       | -              | Get Date and Time      |
| DATABASE | N       | -              | Get Number of Record   |
|          | G       | Number         | Read Record by Number  |
|          | E       | -              | Erase All Record       |

**Reply Index Table**

| Topic | Reply | Contents              | Description      |
|-------|-------|-----------------------|------------------|
| ACK   | A     | Reply Information     | ACK+ Information |
| NAK   | N     | See Error Index Table | NAK+ Information |

**Error Index Table ( For Reply NAK )**

| Topic        | Error Index | Description                     |
|--------------|-------------|---------------------------------|
| ACCESS LEVEL | 00          | Access Denied or Password Error |
| COMMAND CODE | 01          | Command packet is too long      |
|              | 02          | Command packet is empty         |
|              | 03          | Command code is out of range    |
|              | 04          | Illegal Command or Data         |
| DATABASE     | 05          | Database and Register is Empty  |
|              | 06          | Record number is out of range   |
|              | 07          | Check Sum Error                 |
|              | 08          | Memory Not Enough               |
|              | 09          | Action Failure                  |
| FILE         | 0A          | File Not Exist                  |

1. GET NUMBER OF RECORD :

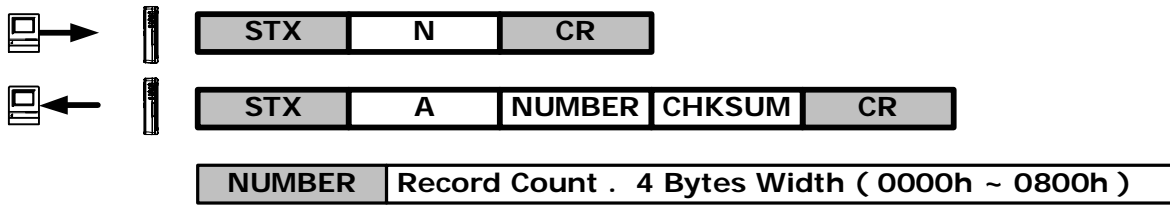

**EXAMPLE**

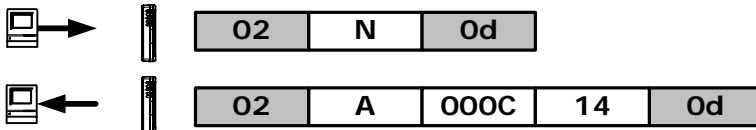

The Total of Record Count : 12

2. READ RECORD BY NUMBER :

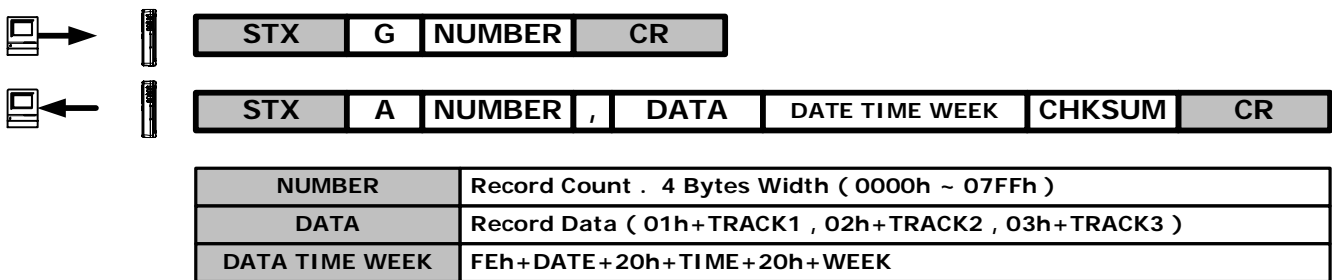

**EXAMPLE**

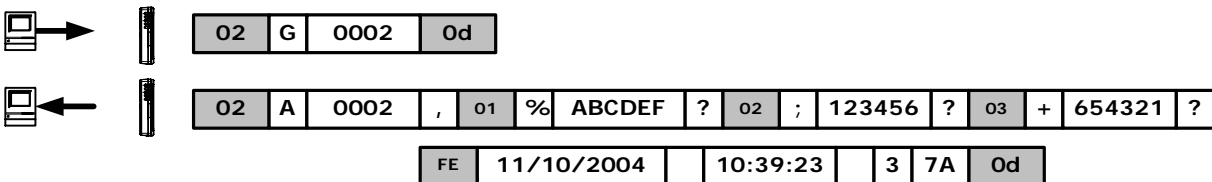

Read Record Number : 12  
 TRACK1 ID : ABCD , TRACK2 ID : 2222 , TRACK3 ID : 3333

3. ERASE ALL RECORD : ( Logical Erase )



**EXAMPLE**

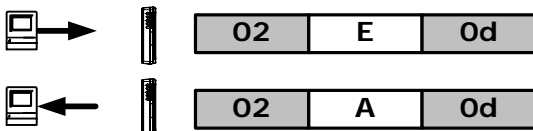

ERASE ALL RECORD



4. ERASE ALL RECORD : ( Physical Erase )

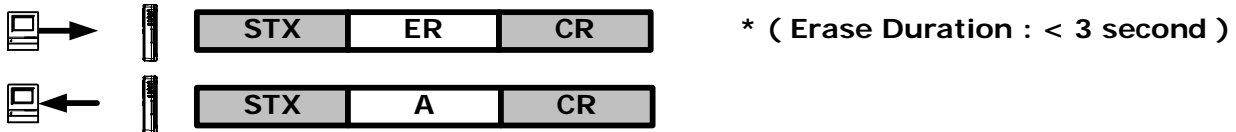

**EXAMPLE**

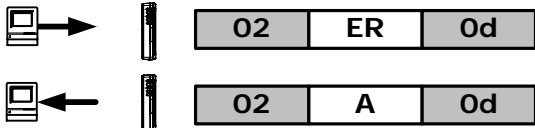

Erase all record ( Can't use the "M" command to recover )

5. RECOVER ALL RECORD :



**EXAMPLE**

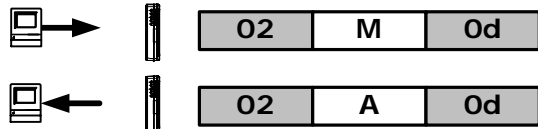

Recover all record

6. LOGIN :

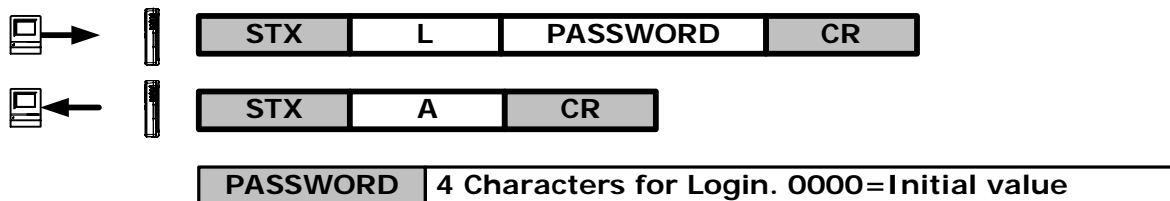

**EXAMPLE**

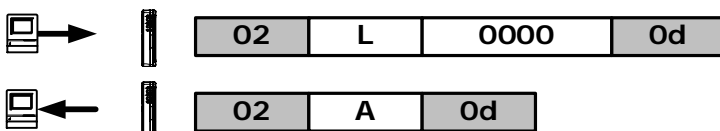

Login password : 0000

7. LOGOUT :

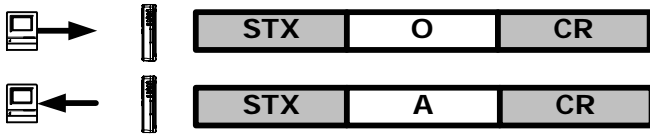

**EXAMPLE**

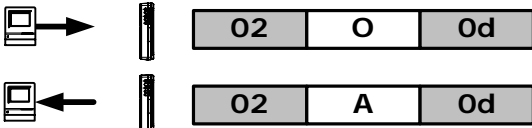

Logout

8. SET PASSWORD :

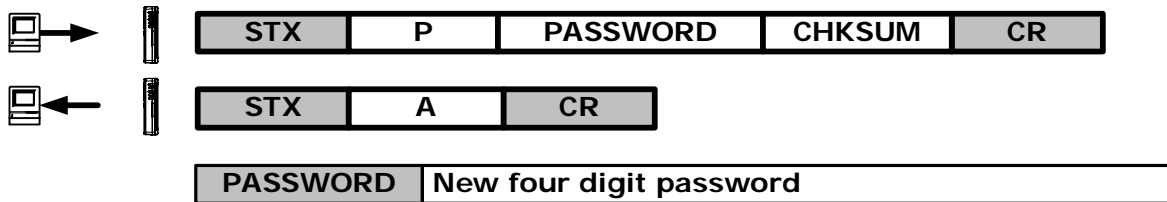

**EXAMPLE**

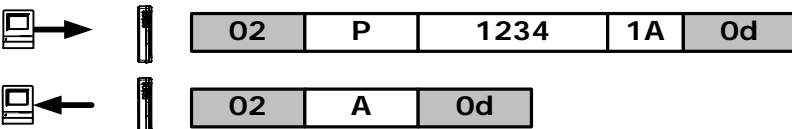

Set new password : 1234

9. ENTER FIRMWARE MANAGEMENT MODE :

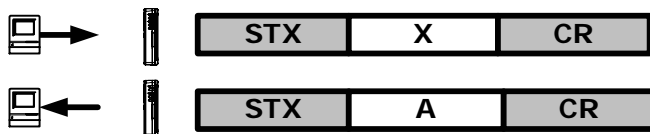

**EXAMPLE**

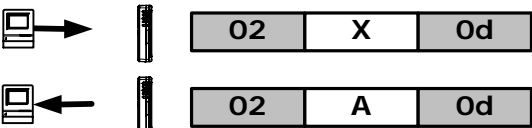

Enter firmware management mode

10. SET DATE AND TIME :



|      |                     |
|------|---------------------|
| YYYY | Year (2000 - 20xx ) |
| MM   | Month (01 - 12 )    |
| DD   | Date ( 01 - 31 )    |
| hh   | Hour ( 00 - 23 )    |
| mm   | Mintue ( 00 - 59 )  |
| ss   | Second ( 00 - 59 )  |
| W    | Week ( 0 - 6 )      |

| Week |   |
|------|---|
| SUN  | 0 |
| MON  | 1 |
| TUE  | 2 |
| WED  | 3 |
| THU  | 4 |
| FRI  | 5 |
| SAT  | 6 |

**EXAMPLE**

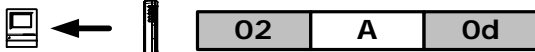
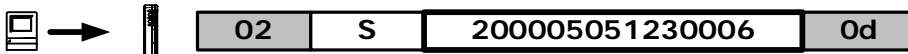

Set Date = 2000 / 5 / 5  
 Set Time = 12 : 30 : 00 , Saturday

11. GET DATE AND TIME:



**EXAMPLE**

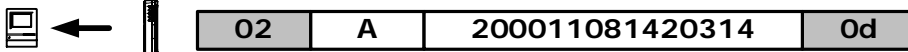
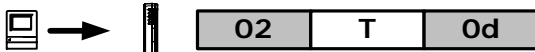

Get Date : 2000 / 11 / 8  
 Get Time : 14 : 20 : 31 , Thursday

12. GET PRODUCT VERSION :



|         |   |
|---------|---|
| ROM No. | ROM-Txxxx , xxxx : Rom serial number                          |
| VERSION | Vx.xxRm , Vx.xx : Firmware version x.xx , Rm : Modify m times |

**EXAMPLE**

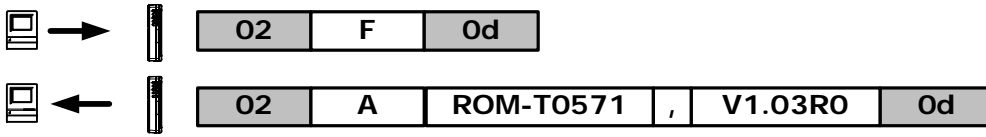

ROM serial number = ROM-T0571  
 Firmware Version = 1.03  
 Modify times = 0

**7. SET REGISTER :**



|          |  |
|----------|--|
| REGISTER | Register Address . 2 Bytes Width ( 00h ~ FFh ) |
| PARAM    | Set Parameters of Register                     |
| CHKSUM   | C + REGISTER + , + PARAM                       |

**8. GET REGISTER :**

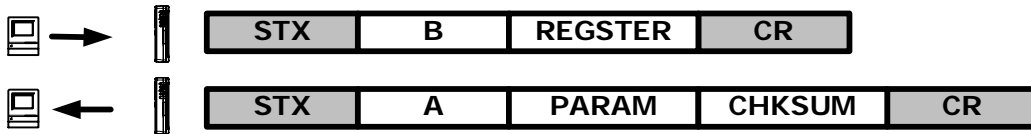

|          |  |
|----------|--|
| REGISTER | Register Address . 2 Bytes Width ( 00h ~ FFh ) |
| PARAM    | Set Parameters of Register                     |

## REGISTER TABLE

| Register | Function                     | Description   |
|----------|------------------------------|---|
| 10h      | Auto Off Duration(Low byte)  | 00~FFh (0~ 255 second )   |
| 11h      | Auto Off Duration(High byte) | -   |
| 12h      | Power Mode                   | 00h: Auto Power Off<br>FFh: Switch<br>Other: Real time                |
| 13h      | Machine ID (High byte)       | 2 Characters  |
| 14h      | Machine ID (Low byte)        |   |
| 15h      | RTC cal. value               | 00 ~ FFh  |
| 16h      | *                            | *   |
| 17h      | *                            |   |
| 18h      | Back Light Duration          | 00~FFh (0~ 255 second )   |
| 19h      | Buzzer                       | 00h: Off<br>FFh: On   |
| 1Ah      | Date Format                  | 00h: mm/dd/yyyy<br>FFh: yyyy/mm/dd<br>other: dd/mm/yyyy               |
| 1Bh      | Display Mode                 | 00h: Tracks Parallel<br>01h: Credit Card Mode<br>other: Tracks Series |
| 1C~1Fh   | *                            | *   |
| 20~2Fh   | User Name                    | 16 Characters   |
| 30~1FBh  | *                            | *   |
| 1FC~1FFh | Password                     | 4 Characters  |

# USB Driver Setup

## Driver Software Installation - For WAS-1571 only

1. Connect **WAS-1571** into the USB PORT of your Computer first.
2. Under Windows **98/2000/Me/XP**, put **DISK5216** into the cd-rom disk driver, it will automatically install the USB232/422/485 Driver Software into your Computer by following the steps as below:

### 1. This wizard searches for new drivers for USB Device



### 2. What do you want Windows to do ?

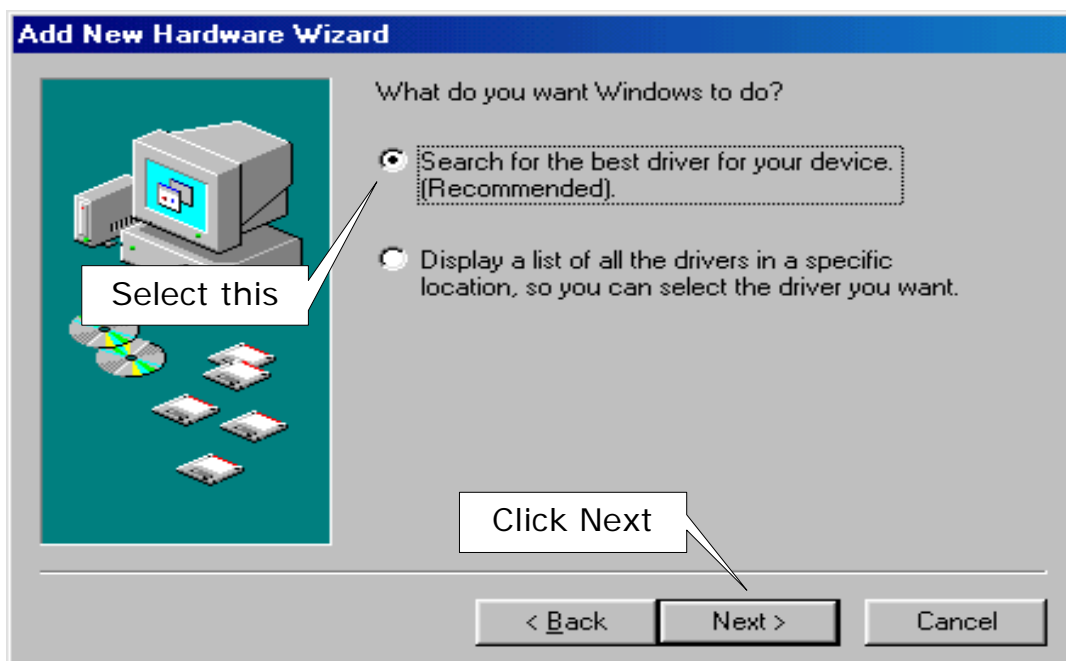

### 3. Select Searching locations for new driver



### 4. Windows is now ready to install the best driver



## 5. Windows has finished installing the software





## 6. Make sure if the driver software installation is finished

Connect WAS-1571 Cable into the USB port of the computer and then Click " Start " -> " Settings " -> " Control Panel " -> " System " -> " Device Manager " to see if there are "USB232/422/485(COM3)" at Ports (COM & LPT) and "USB232/422/485 "at Universal Serial Bus controllers.

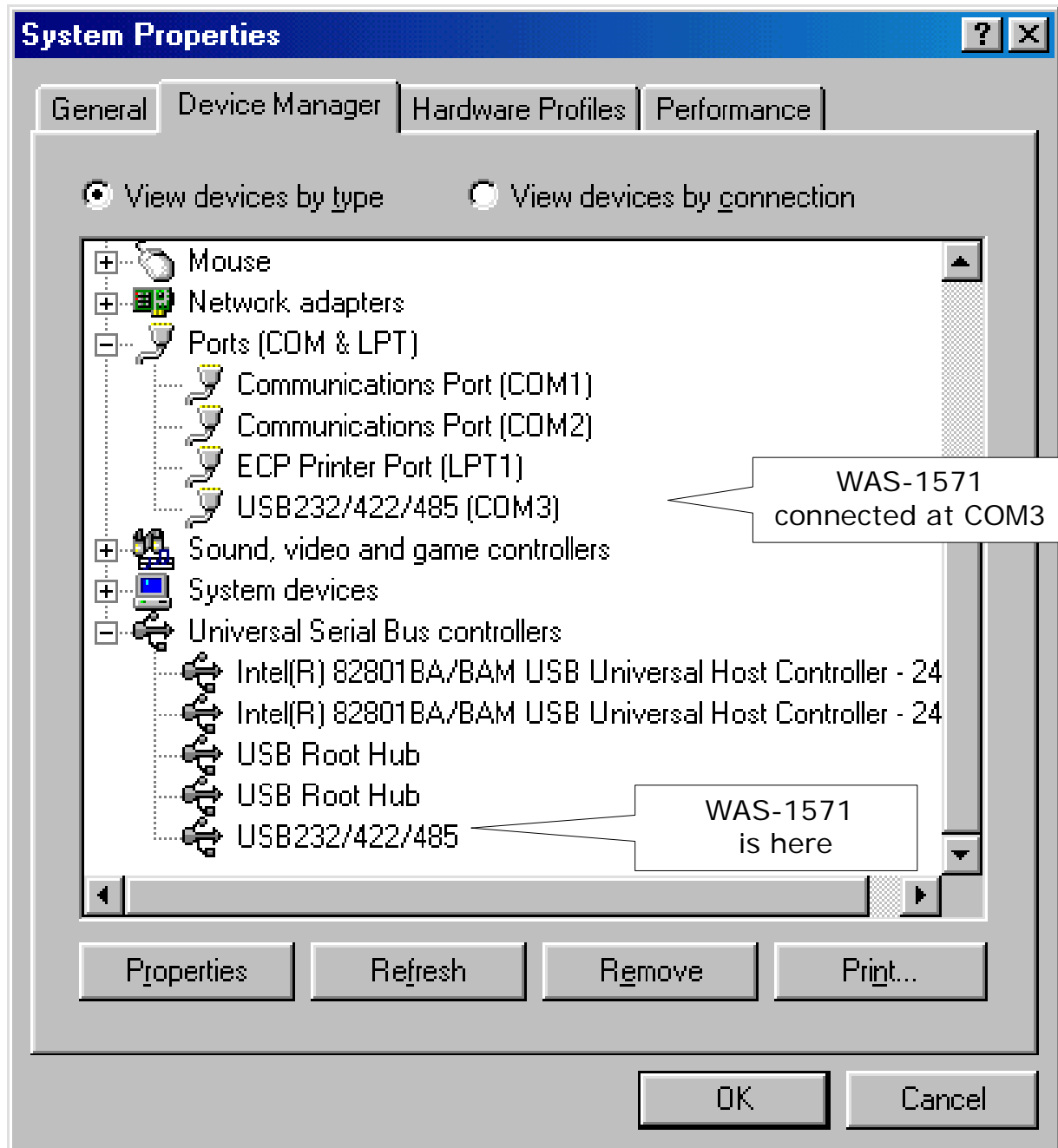

# Remove Driver Software

## How to remove USB232/422/485 Driver Software from your computer-

Put DISK5216 into the CD-ROM drive of the computer and then find and execute Uninstall.EXE by following the steps as below:

### 1. Execute Uninstall.EXE program

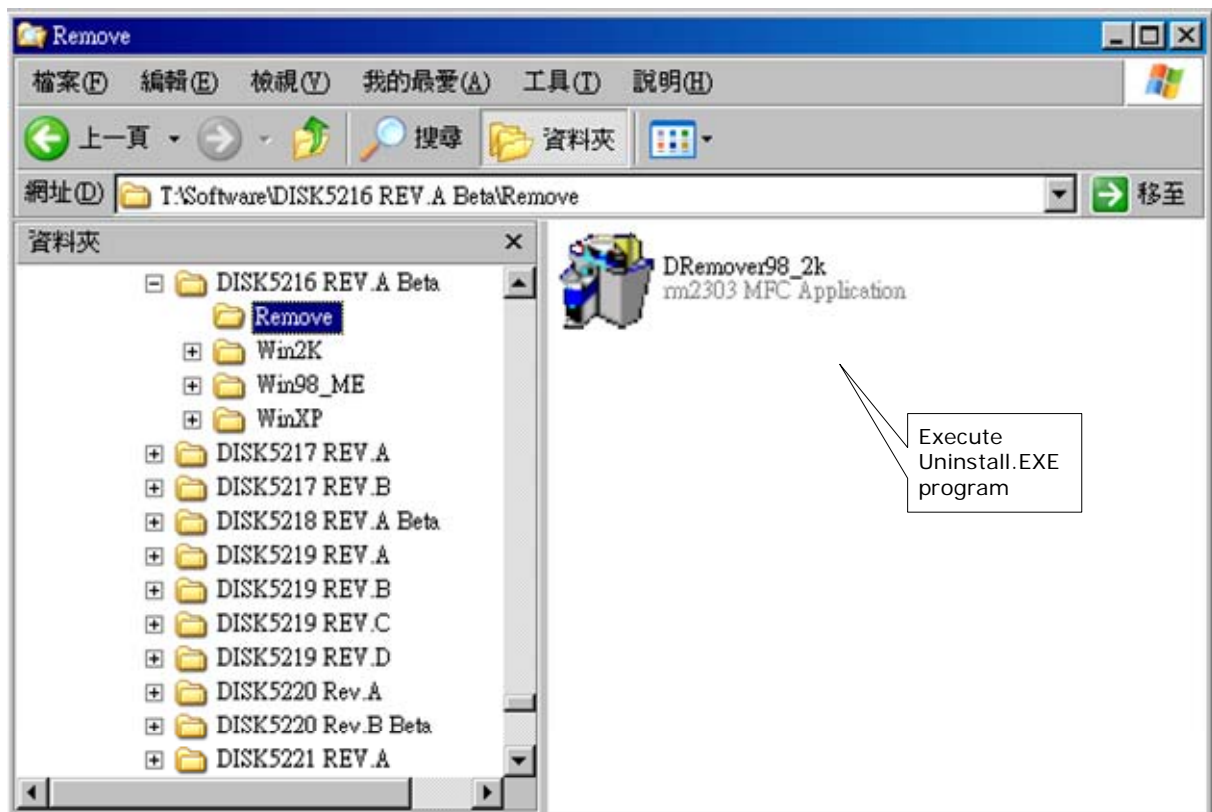

### 2. Confirm to execute Remove program



### 3. Re-boot the Computer after remove program is done

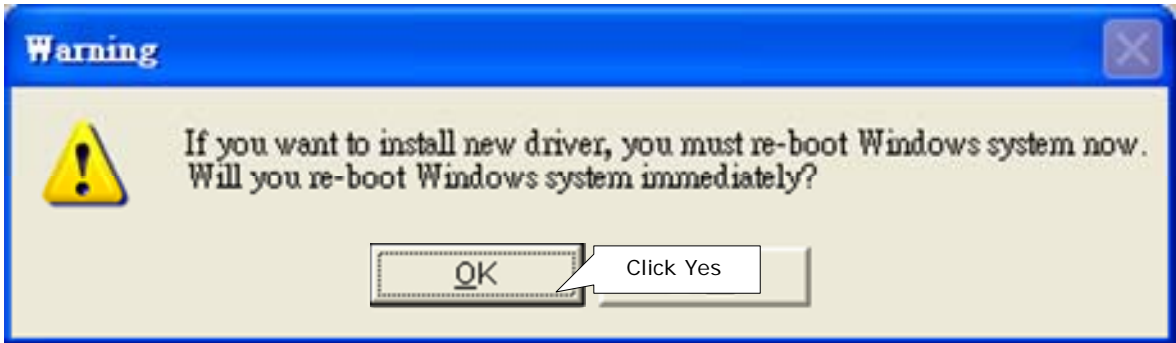

or click "No" button for show as below :

