



ALN-9740

SQUIGGLE INLAY (HIGGS™ 4)

The Alien Technology® ALN-9740 Squiggle® is a high-performance, general-purpose RFID inlay for use in a wide variety of applications. Brings all the Higgs™ 4 advantages to highly-regarded “Squiggle” Inlay.

Applications

- Volume Retail/Apparel
- Enterprise Wide Asset Management
- Warehouse Management
- Tracking Challenging Materials and Objects



FEATURE	DESCRIPTION	BENEFIT
One of the most widely-used general-purpose tags, now with an optimized memory footprint.	Well-proven design for a broad range of worldwide applications. Optimized 448 bit memory footprint for volume and enterprise applications.	Robust, proven, and reliable. Designed to drive down the cost-of-ownership while increasing efficiencies of RFID solutions in large enterprises.
One of the best performing general-purpose tags on the market, now with next generation Higgs™ 4 performance.	Optimized for high performance in all world regions. Higgs™ 4 further enhances read and write sensitivity.	Trusted performance now even further enhanced, enabling robust encoding and reading, even in challenging conditions.
Designed to work well in challenging dielectric environments.	A very robust general purpose tag.	Reliable in challenging environments.

Features:

- › Designed to meet EPCglobal Gen2 (V1.2.0) and ISO/IEC 18000-6C
- › Worldwide operation in the RFID UHF bands (840-960 MHz)
- › 448-Bits of NVRAM Memory
 - 128-EPC Bits
 - 128 User Bits
 - 64 Bit Unique TID
 - 32 Bit Access and 32 bit Kill Passwords
- › Pre-Programmed with a unique, unalterable 64-bit serial number
- › User Memory can be Block Perma-Locked as well as read password protected in 32 Bit Blocks
- › Low power operation for both read and program
- › Dynamic Authentication™ - anti-cloning/anti-counterfeit technology
- › Exceptional operating range, up to 11m with appropriate antenna.
- › Available in high-yield, high capacity dry/wet inlay rolls

Product Overview:

Powered by Alien®’s volume focused **Higgs™ 4 UHF RFID IC** and innovative **Squiggle** antenna design, the ALN-9740 delivers industry leading EPC Gen 2 performance and reliability at a competitive price.

ALN-9740 inlays are *World Tag* compliant, enabling consistent operation across the diverse frequencies of the Americas, Europe, Middle East, Asia, and Africa.

With its Higgs-4 core, the Squiggle delivers next generation performance and a rich feature set, yet is completely **optimized for the highest volume enterprise, retail, and apparel applications.**

An optimized memory footprint includes a 32-bit TID, a **64-bit Unique TID for authentication** and **next generation serialization** applications, a **128-bit EPC memory** bank, 128-bits of user memory for distributed data applications, and **password protected read and write** support capabilities to prevent unauthorized viewing and modification of the tag’s data.

Typical applications for the Squiggle include, but are not limited to, corrugate cases, pallet placards, apparel hang tags, baggage tags, shipping labels, asset management, and file folder labels.



ALN-9740 Inlay Orientation

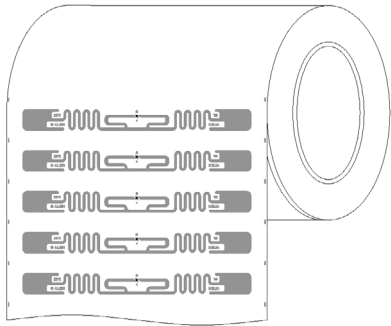

ALN-9740-R
(Dry Unslit Roll)

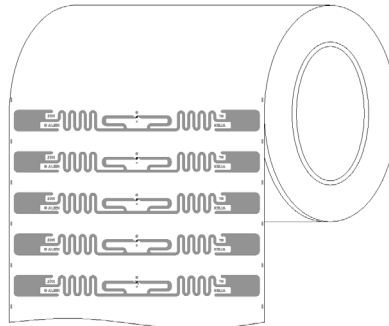

ALN-9740-SR
(Dry Slit Roll)

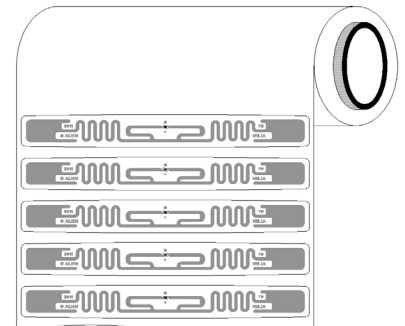

ALN-9740-WRC / -WRW
(Clear / White Wet Inlay)

Standard Alien Inlay rolls unwind with metal antenna side facing outward, with respect to the core.

ALN-9740 Inlay Specification

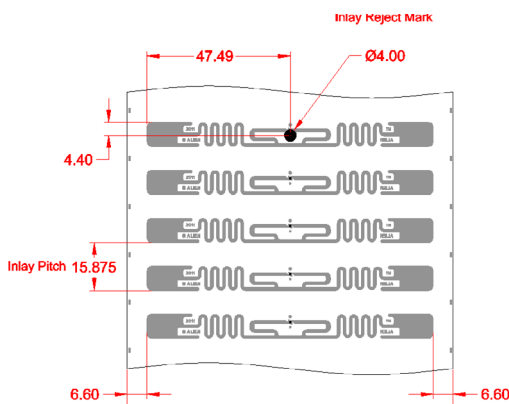

ALN-9740-R
(Dry Unslit Roll)

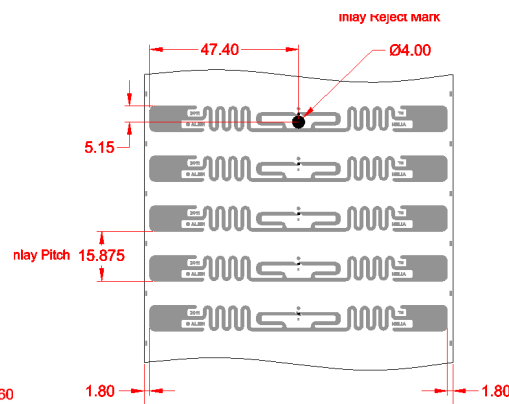

ALN-9740-SR
(Dry Slit Roll)

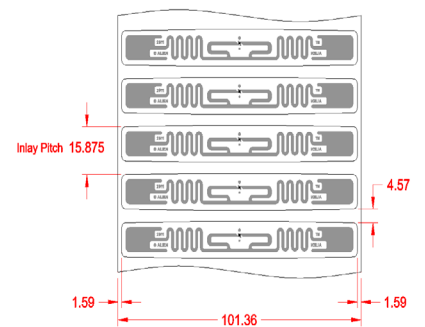

ALN-9740-WRC / -WRW
(Clear / White Wet Inlay)





ALN-9740 Inlay General Dimensions

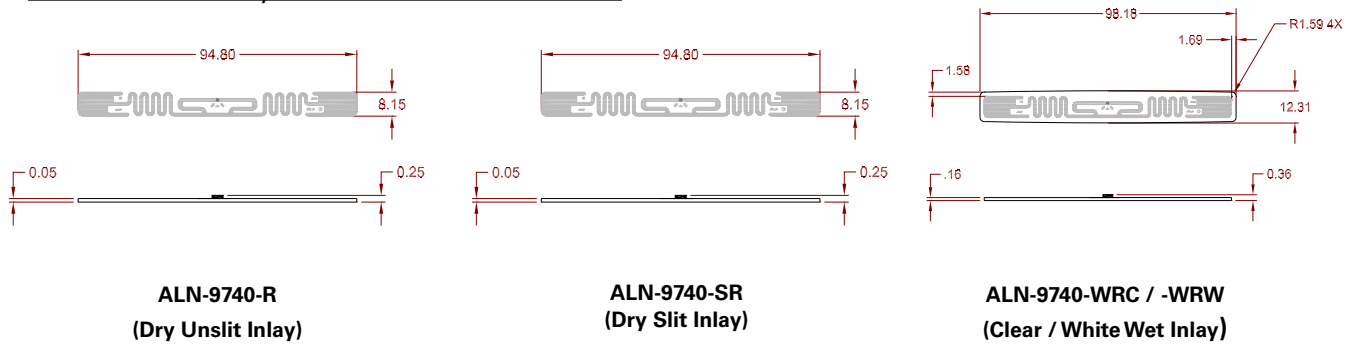

ALN-9740 Inlay Stackup

DRY INLAY THICKNESS, ±10%	
OVER ANTENNA	0.05 mm
OVER CHIP	0.25 mm



ALN-9740-R / -SR
(Dry Unslit / Slit Inlay)

CLEAR WET INLAY THICKNESS, ±10%	
OVER ANTENNA	0.08 mm
OVER CHIP	0.28 mm



ALN-9740-WRC
(Clear Wet Inlay)

WHITE WET INLAY THICKNESS, ±10%	
OVER ANTENNA	0.16 mm
OVER CHIP	0.36 mm*
* Limited release	
	0.31mm



ALN-9740-WRW
(White Wet Inlay)

ALN-9740 Inlay Angular Sensitivity

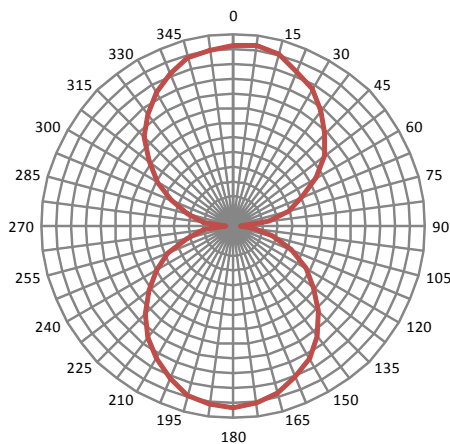

Angular Sensitivity
(Relative Read Range vs. Orientation)

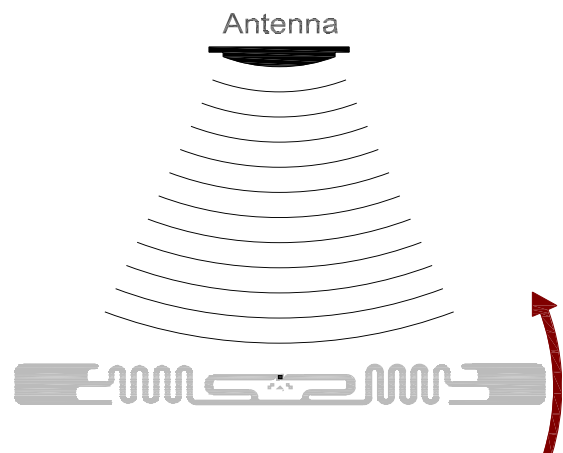

Angular Sensitivity
Inlay is rotated in the x, y, plane about the z axis
(tag shown at 0° with respect to face of antenna)



ALIEN. ALN 9740 Squiggle Inlay

ALN-9740 Specifications

Dry Inlay	
Antenna Width	3.732" [94.8mm]
Antenna Length	0.319" [8.1mm]
Web Width (-R)	4.252" [108.0mm]
Web Width (-SR)	3.874" [98.4mm]
Web Pitch	0.625" [15.875mm]
Core Width (-R)	4.252" [108.0mm]
Core Width (-SR)	3.874" [98.4mm]
Core ID	6" [152.4mm]*
Core Material	Fiberboard
Inlays per Roll	20,000 Nominal
Maximum Roll OD	< 12" [304.8mm]
Roll Labeling Data	Roll #, Quantity

Wet Inlay	
Inlay Width	3.866" [98.2mm]
Inlay Length	0.484" [12.3mm]
Web Width	3.992" [101.4mm]
Web Pitch	0.625" [15.875mm]
Core Width	4.752" [120.7mm]
Core ID	6" [152.4mm]*
Core Material	Fiberboard
Inlays per Roll	20,000 Nominal
Maximum Roll OD	< 16" [406.4mm]
Roll Labeling Data	Roll #, Quantity
White (-WRW)	TT Printable White Film Overlay
Overlay Adhesive (-WRW)	General Purpose Permanent
Inlay Adhesive	General Purpose Permanent
Adhesive Application Temperature	> +25°F [-4°C]
Adhesive Service Temperature	-40°F to +200°F [-40°C to +93.3°C]
Release Liner	40# SCK

Environmental	
Shelf Life	Dry Inlays: 5 years at +77°F [+25°C] @ 40% RH Wet Inlays: 2 years at +77°F [+25°C] @ 40% RH
Recommended Storage	+77°F [+25°C] @ 40% RH
Storage Limits	-13°F to 122°F [-25°C to +50°C] 20% to 90% RH Non-condensing
Operating Limits	-40°F to +158°F [-40°C to +70°C] 20% to 90% RH Non-condensing
Bend Diameter	> 1.97" [50mm]
Pressure	< 5N/mm ²
Drop Resistance	Per ASTM D5276
Write Cycles	100,000 @ 25°C
RoHs	2002/95/EC, 2005/618/EC, 2011/65/EU Compliant
REACH	1907/2006/EC Compliant (SVHC and ECHA)
ESD Limit- HBM / CDM	5.0kV / 1.5kV

RFID	
Protocols Supported	ISO/IEC 18000-6C EPCglobal Class 1 Gen 2
Integrated Circuit	Alien Higgs-4
EPCglobal Certificate	950110126000001084
Operating Frequency	840-960 MHz
EPC Size	128 Bits
User Memory	128 Bits
TID	32 Bits
Unique TID	64 Bits
Access Password	32 Bits
Kill Password	32 Bits

* Shipped with 6" to 3" plastic core adapter

May 4, 2017

Copyright© 2017 Alien Technology LLC. All rights reserved.

Alien, Alien Technology, the Alien Technology logo, Spider, Higgs, Dynamic Authentication, QuickWrite, BlockWrite, Squiggle, and the Squiggle logo are trademarks or registered trademarks of Alien Technology Corporation in the U.S. and other countries.

HANDLING PRECAUTIONS Observe standard handling practices to minimize ESD.

DISCLAIMER Application recommendations are guidelines only - actual results may vary and should be confirmed. This is a general purpose product not designed or intended for any specific application.

This product is covered by one or more of the following U.S. patents: 7967204, 7931063, 7868766, 7378255, 7716208, 7716160, 7688206, 7659822, 7619531, 7615479, 7598867, 7580378, 7576656, 7562083, 7561221, 7559486, 7559131, 7554451, 7551141, 7542301, 7542008, 7531218, 7522055, 7500610, 7489248, 7453705, 7425467, 7417306, 7411503, 7385284, 7377445, 7364084, 7353598, 7342490, 7324061, 7321159, 7301458, 7295114, 7288432, 7265675, 7262686, 7260882, 7253735, 7244326, 7218527, 7199527, 7193504, 7173528, 7172910, 7172789, 7141176, 7113250, 7101502, 7080444, 7070851, 7068224, 7046328, 6998644, 6988667, 6985361, 6980184, 6970219, 6952157, 6942155, 6933848, 6927085, 6816380, 6780696, 6731353, 6693384, 6683663, 6665044, 6657289, 6623579, 6606247, 6606079, 6590346, 6586338, 6566744, 6555408, 6527964, 6479395, 6468638, 6420266, 6316278, 6291896, 6281038. Other patents pending.

This product is licensed under patents of Round Rock Research, LLC, for use solely with UHF RFID Readers (such as Alien reader products) that are licensed under an agreement with Round Rock Research, LLC.



Alien Technology
845 Embedded Way
San Jose, CA 95138-1030
866-RFID NOW
www.alientechnology.com