

DATAMAN 470 SERIES BARCODE READERS

Premium fixed-mount barcode readers
for the most challenging applications



COGNEX

DATAMAN 470 SERIES BARCODE READERS

Premium fixed-mount barcode readers for the most challenging applications

DataMan 470 series fixed-mount barcode readers solve complex, high-throughput manufacturing and logistics applications with ease. DataMan 470's multi-core processing power, new HDR+ imaging technology, high-resolution sensor, advanced algorithms, and simple setup delivers maximum coverage, speed, and ease-of-use.

DataMan 470 excels at reading a wide range of codes including:

- Challenging 1D, 2D, and direct part mark (DPM) codes
- Multiple 1D and 2D codes with mixed symbologies
- Small Data Matrix codes
- Severely damaged 1D codes



Fast, powerful performance solves challenging applications

The DataMan 470 barcode reader has seven powerful processing cores, enabling it to run multiple algorithms and processes in parallel at astonishing speeds. It reads challenging 1D and 2D codes in varied locations, as well as multiple mixed symbologies simultaneously while maintaining the highest decode rates.



High-Speed Code Reading

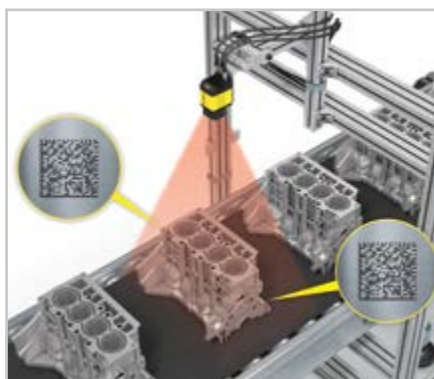

Varied Location Code Reading



Mixed Symbology,
Multi-Code Reading

New imaging technology for advanced image formation



High Dynamic Range (HDR) imaging uses the latest CMOS image sensor technology which is 16x more detailed than conventional sensors. HDR takes advantage of the extra available image data to globally enhance image quality and contrast.

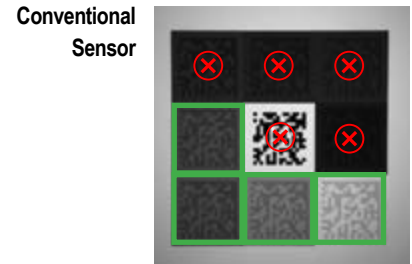

HDR+ is an advanced, patent-pending algorithm that stretches the boundaries of HDR technology by further increasing localized contrast changes automatically. This creates a more uniformed image in a single acquisition allowing greater depth-of-field, faster line speeds, and improved handling of difficult codes.

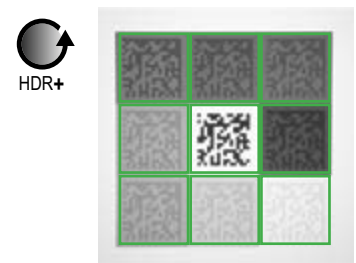
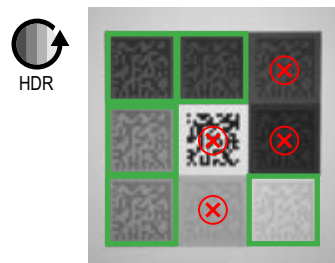

HDR+ technology enables DataMan 470 to read an increased range of codes than is possible with conventional or other HDR technologies.

Greater Depth-of-Field

HDR+ reduces over- and under-exposure, providing greater depth-of-field, above and beyond HDR technology and conventional imaging sensors.

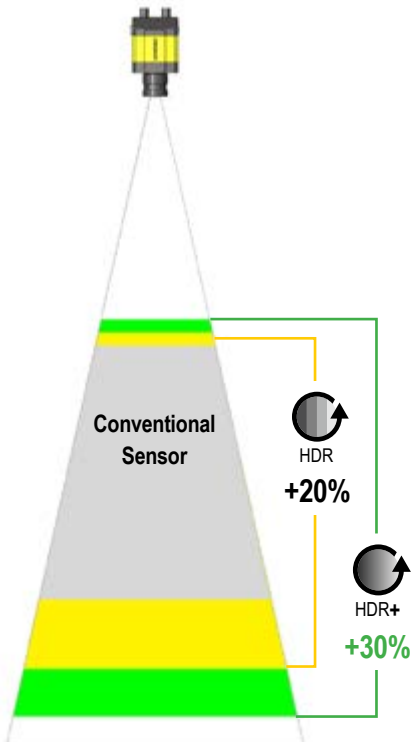

Faster Line Speeds

HDR+ significantly reduces exposure times, increasing line speed possibilities by more than 80%.

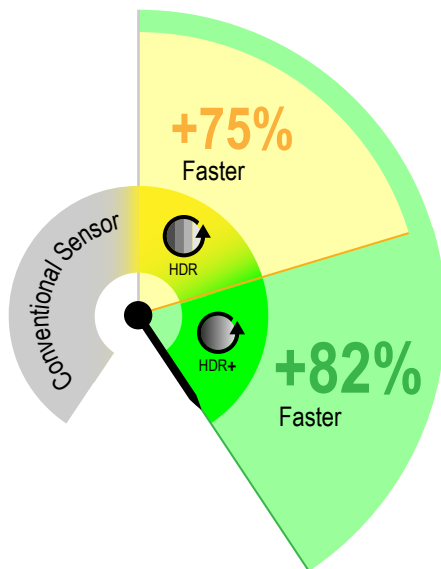

Improved Code Handling

HDR+ allows DataMan 470 to adjust contrast ranges to read difficult codes with variant backgrounds that cannot be read with conventional technology.

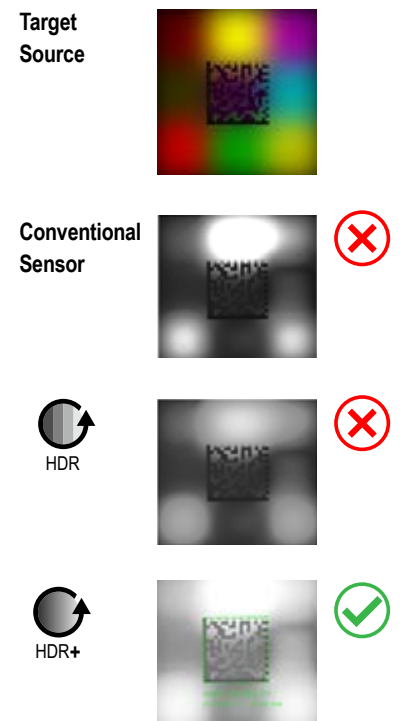

99.9% read rates for optimal throughput and traceability

DataMan 470 series is optimized with patented technologies and advanced algorithms to ensure continuously high read rates of 1D and 2D symbologies, regardless of size, quality, printing method, or surface.



1DMax Advanced Algorithm

1D barcode reading algorithm is optimized for omnidirectional barcode reading and extreme variations in contrast, blur, damage, resolution, quiet zone violations, and perspective distortion.

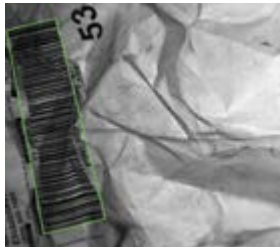

2DMax Advanced Algorithm

2D barcode reading algorithm provides reliable 2D code reading despite code quality, printing method, or surface type.



Hotbars Image Analysis Technology

Hotbars technology locates and extracts 1D barcodes up to 10x faster than a typical reader, even with increased noise, large specular reflection, reduced quiet zone, limited contrast, and damage.

	TYPICAL 1D ALGORITHM	HOTBARS IMAGE ANALYSIS
Noise		
Specularity		
Perspective		
Quiet Zone		
Contrast		
Damage		



PowerGrid Technology

PowerGrid technology quickly locates 2D codes that exhibit significant damage to or complete elimination of a code's finder pattern, clocking pattern, or quiet zone.



No finder pattern



No finder or clocking pattern



Quiet zone violation



Stripe



Modular options provide maximum flexibility

DataMan 470's innovative design with modular lighting, lens, and communication options adjusts to solve any barcode reading application.



RS-232, Ethernet with industrial protocols, SD card, and other network connectivity options



S-mount, C-mount, and liquid lens (autofocus) options for maximum application coverage

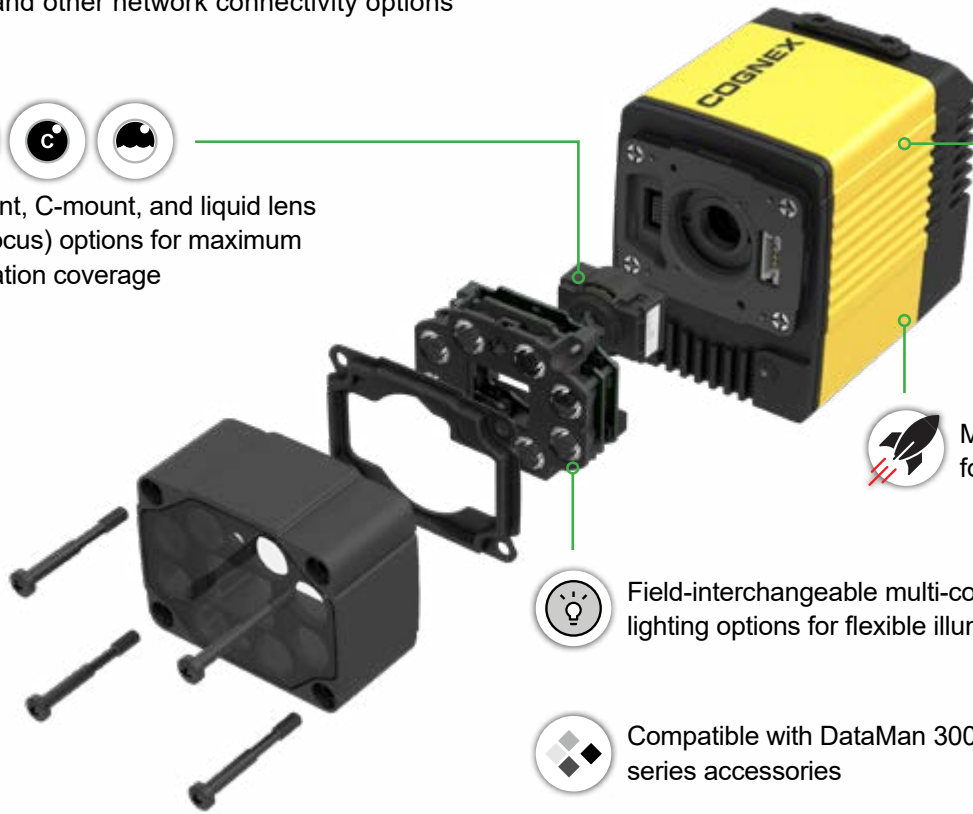

HDR and HDR+ technology for advanced image formation



Multi-core processing power for high speed decoding



Field-interchangeable multi-color and polarization lighting options for flexible illumination



Compatible with DataMan 300/360 series accessories

Model Options	Reads
L*	1D fixed position barcodes
QL*	1D omnidirectional barcodes
Q	High-speed 1D and 2D codes
X*	Challenging 1D and 2D codes, including DPM codes

*Multi-reader sync option available



Performance feedback

DataMan 470 series includes Gigabit Ethernet for fast, full-resolution image transfer to help diagnose the cause of unread codes. Available Cognex Real Time Monitoring (RTM) technology provides performance feedback of DataMan 470 in easy-to-use dashboards to help with process optimization.

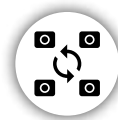

Multi-Reader Sync

Allows multiple DataMan 470 readers to synchronize for extended field-of-view or for multi-side scanning. The primary reader collects data from the secondary readers and communicates the overall result to the control system.

Easy setup and operation

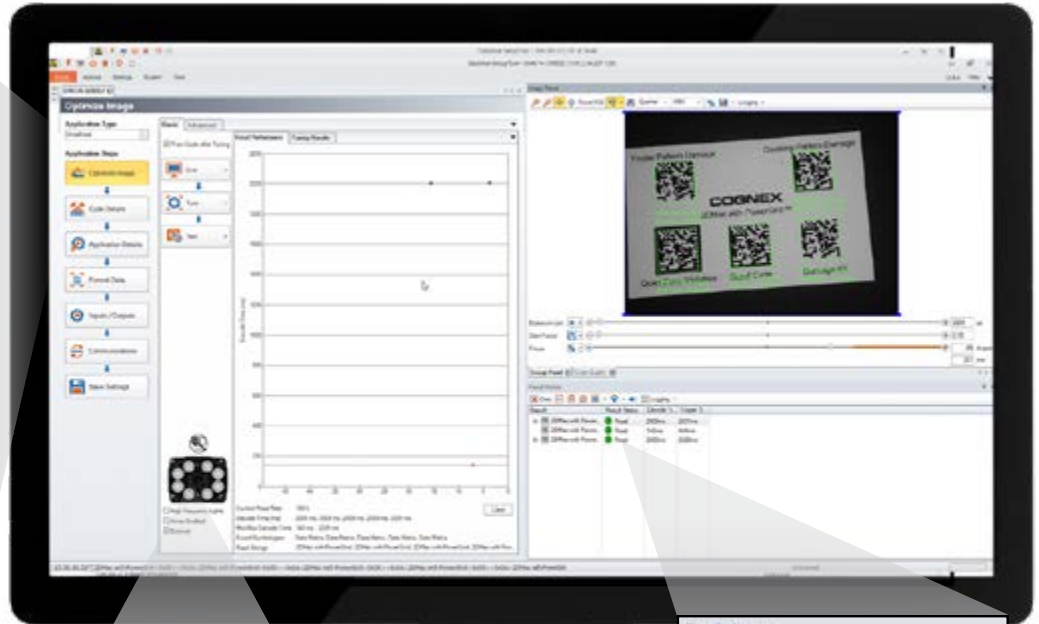
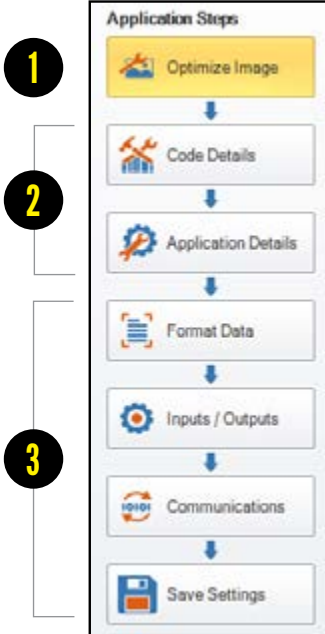

Step-by-step installation flow for easy and efficient setup



Independent light control

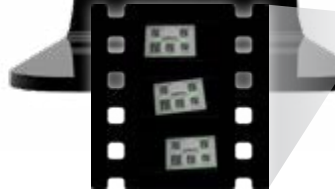

Image transfer

Result	Result Status
2D DIAMONDS	Read
2D DIAMONDS	Read
2D DIAMONDS	Read
2D DIAMONDS	Read
2D DIAMONDS	Read
2D DIAMONDS	Read
2D DIAMONDS	Read
2D DIAMONDS	Read

Read result history

Application assistants for visual guidance

Application assistants provide basic and advanced visual application guidance, allowing for quick and reliable optimization of complex parameters for simple and challenging applications. Intelligent tuning automatically adjusts lighting, height, and other variable conditions for codes on various parts and surfaces.

Trigger Assistant

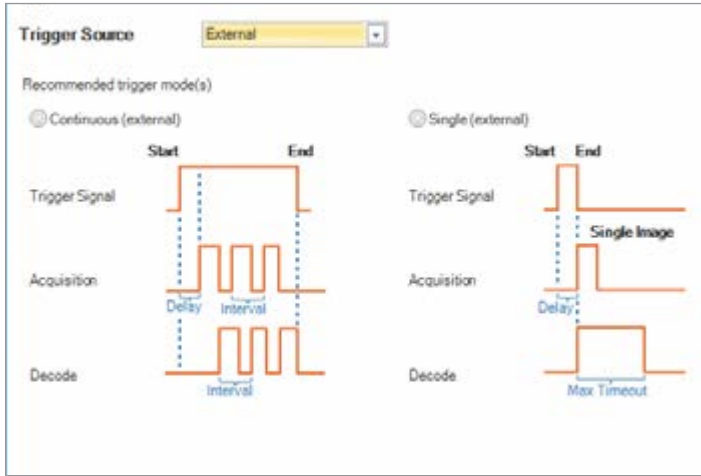

Exposure Assistant

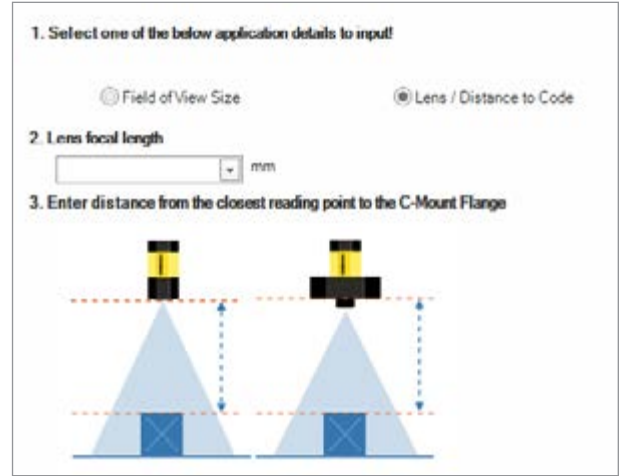

Unprecedented field-of-view coverage with fewer readers

DataMan 470's high-resolution 3.1-megapixel sensor enables greater field-of-view and depth-of-field coverage than other readers. It reads large and small codes from various angles, including high density 2D DPM codes.

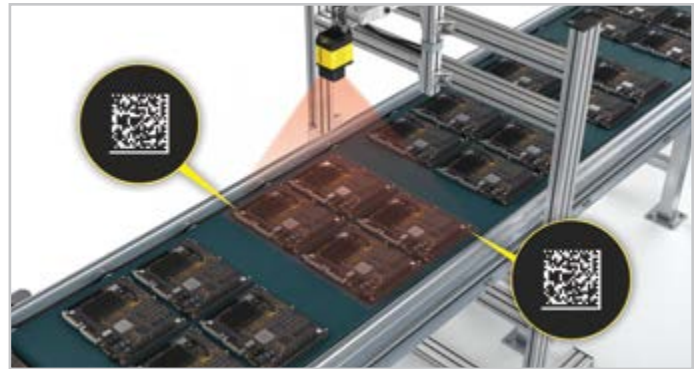
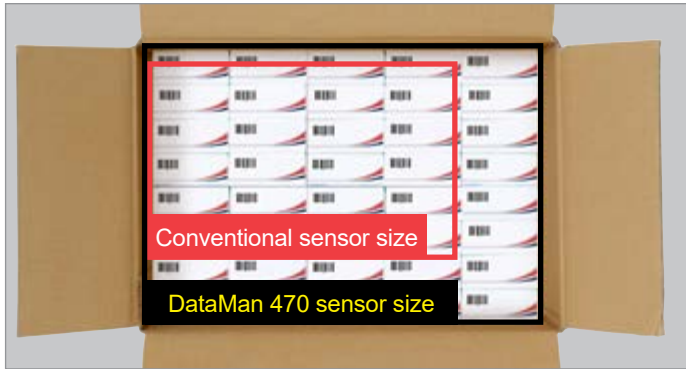

DataMan 470's higher resolution provides expanded field-of-view capabilities to read multiple codes and mixed symbologies with ease.

Increased sensitivity and reduced noise

The new 12-bit CMOS image sensor technology provides greater dynamic range than conventional sensors. With increased sensitivity and reduced noise, DataMan 470 can capture clearer images which are 16x more detailed.



Image taken with conventional 8-bit sensor



Image taken with DataMan 470 12-bit sensor

DataMan 470 range

A single DataMan 470 barcode reader offers extensive field-of-view and reading distances with liquid lens (autofocus) technology.

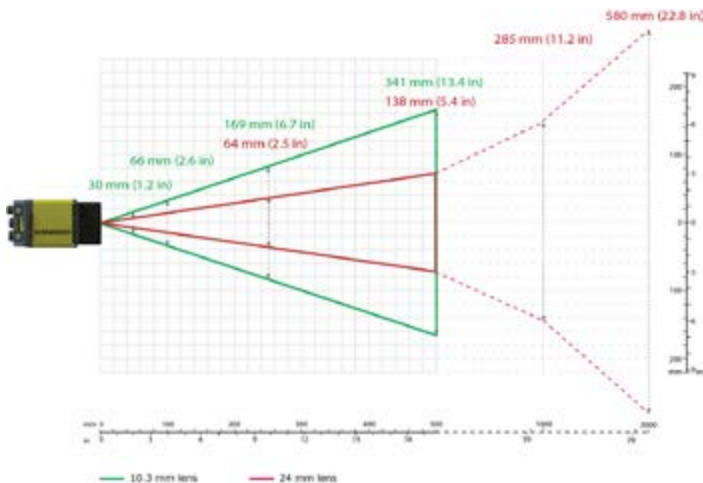

Xpand technology

The Xpand technology accessory is also available to increase the field-of-view coverage of a single barcode reader by over 50%.

Single Reader

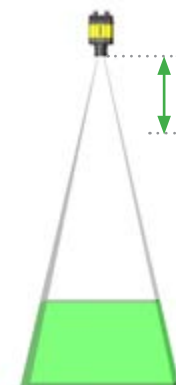

Single Reader + Xpand Accessory

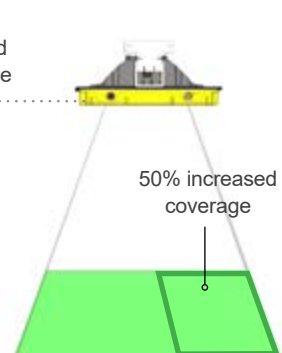

DATAMAN 470 SERIES SPECIFICATIONS

	DataMan 474	DataMan 475
Algorithms and Technologies	1DMax, 2DMax, Hotbars, PowerGrid	
Image Sensor	1/1.8" CMOS	2/3" CMOS
Image Sensor Properties	Diagonal 8.9 mm; 3.45 μ m square pixels	Diagonal 11.1 mm; 3.45 μ m square pixels
Image Sensor Resolution	2048 x 1536	2448 x 2048
Electronic Shutter Speed	Min. exposure: 15 μ s Max. exposure: 1000 μ s with internal illumination/10000 μ s with external illumination	
Max Acquisition	Up to 80 Hz	Up to 55 Hz
Lens Options	Liquid lens 10 mm, 16 mm, 24 mm; C-mount 12 mm, 16 mm, 25 mm, 35 mm, 40 mm	
Trigger and Tune Buttons	Yes; Quick Setup Intelligent Tuning	
Aimer	Optional	
Discrete Inputs	2 fixed + (*) opto-isolated	
Discrete Outputs	2 fixed + (*) opto-isolated	
*Other I/O Points	2 user-configurable	
Status Outputs	Beeper, 5 multifunctional LEDs, 10 LED bar array, 360 degree indicator	
Lighting	Integrated LEDs, red, blue, or IR; diffuse, polarized, high powered integrated light (HPIL), high powered integrated torch (HPIT), various controllable external light options	Integrated LEDs, red, blue or IR; diffuse, polarized, high powered integrated torch (HPIT), various controllable external light options
Communications	Ethernet and Serial	
Protocols	RS-232, TCP/IP, PROFINET, EtherNet/IP(TM), SLMP, Modbus TCP, NTP, SFTP, FTP, MRS Java Scripting enabled for custom protocols	
Power	24 VDC \pm 10%	
Power Consumption	24 VDC \pm 10%, 1.5 A maximum (HPIL/HPIT ¹) 24 VDC, 250 mA maximum (reader) Supplied by LPS or NEC class 2 only	
Weight	373 g	
Dimensions	126.8 mm (L) x 60.5 mm (W) x 77.1 mm (H)	
Operating Temperature	0–57 °C (32–134.6 °F) ²	
Storage Temperature	-20–80 °C (-4–176 °F)	
Operating and Storage Humidity	< 95% non-condensing	
Protection	IP67 with cables and appropriate lens cover attached	
RoHS Certified	Yes	
Approvals (CE, UL, FCC)	Yes	

¹ HPIL denotes one of the DM360-HPIL-RE, DM360-HPIL-RE-P, DMLT-HPIL-RE or DMLT-HPIL-RE-P accessories. HPIT denotes one of the DMLT-HPIT-RE-W, DMLT-HPIT-RE-S, DMLT-HPIT-RE-N, DMLT-HPIT-WHI-W, DMLT-HPIT-WHI-S, DMLT-HPIT-WHI-N accessories.

² In situations where the operating temperature exceeds 40 °C, an external heat sink is required.

COGNEX

Companies around the world rely on Cognex vision and barcode reading solutions to optimize quality, drive down costs and control traceability.

Corporate Headquarters One Vision Drive Natick, MA 01760 USA

Regional Sales Offices

Americas

North America +1 844-999-2469
Brazil +55 (11) 2626 7301
Mexico +01 800 733 4116

Europe

Austria +49 721 958 8052
Belgium +32 289 370 75
France +33 1 7654 9318
Germany +49 721 958 8052

Hungary +36 800 80291
Ireland +44 121 29 65 163
Italy +39 02 3057 8196
Netherlands +31 207 941 398
Poland +48 717 121 086
Spain +34 93 299 28 14
Sweden +46 21 14 55 88
Switzerland +41 445 788 877
Turkey +90 216 900 1696
United Kingdom +44 121 29 65 163

Asia

China +86 21 6208 1133
India +9120 4014 7840
Japan +81 3 5977 5400
Korea +82 2 539 9980
Malaysia +6019 916 5532
Singapore +65 632 55 700
Taiwan +886 3 578 0060
Thailand +66 88 7978924
Vietnam +84 2444 583358

© Copyright 2019, Cognex Corporation.
All information in this document is subject to change without notice. All Rights Reserved. Cognex and DataMan are registered trademarks of Cognex Corporation. All other trademarks are property of their respective owners.
Lit. No. DSDM470-03-2019

www.cognex.com