

TC22 and TC27 Accessories Guide

The ultimate cost-effective
tool for small businesses —
with big business features

Revised Feb 2025

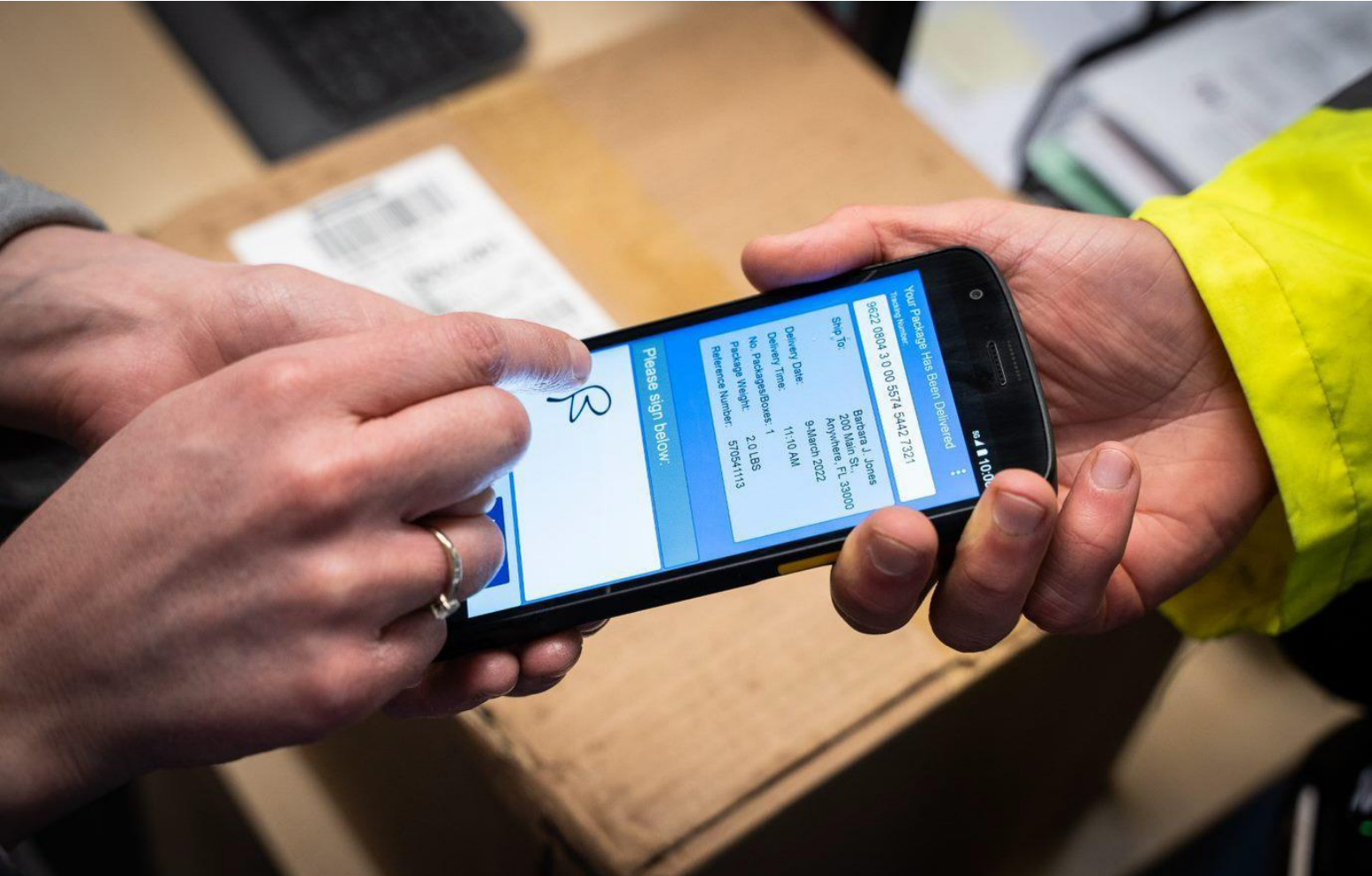

I.	Accessories that POWER devices	
1	Cradles	
1.1	Single-slot cradles	3
1.2	Multi-slot cradles	4
1.3	Cradle cups	5
1.4	Mounting options for chargers	6
2	Batteries	
2.1	Spare Li-on Bluetooth batteries	7
2.2	Spare Li-ion batteries	7
2.3	Spare battery chargers	8
3	Power supply, cables, and adapters	
3.1	Power supply and cable matrix	9
3.2	Country-specific AC line cords	10
II.	Accessories that ENABLE productivity solutions	
4	Headsets	
4.1	Wired headsets and accessories for Workcloud Sync	12
4.2	Wired headsets and accessories for voice-directed picking	13
4.3	Wireless headsets and accessories for voice-directed picking	13
4.4	Cables and adaptors	14
5	Wearable mounts and other accessories	
5.1	Arm / wrist mounts	15
5.2	Replacement straps and arm sleeves	16
5.3	Replacement straps, hand strap, and comfort pad	17
5.4	Stylus and Tether	18
6	Trigger handles	
6.1	Electronic Trigger Handle	19
III.	Accessories that PROTECT devices	
7	Soft holsters, rugged boots, and screen protectors	
7.1	Soft holsters, rugged boots, and screen protectors	20
IV.	Workstation Connect Cradle	
8	Workstation Connect Cradle	21
V.	Third Party Accessories for TC22/27	
9	3rd Party Accessories for TC22 / 27	22

Single-slot cradles



Single-slot charger cradle

SKU# CRD-TC2L-BS1CO-01

Single-slot charge-only cradle for one TC22 / TC27 device.

- Charges standard capacity battery from 0 to 80% in less than 2 hours 20 minutes.
- Charges extended capacity battery from 0 to 80% in less than 3 hours 10 minutes.
- Compatible with TC22 / TC27 units with hand straps, trigger handle or protective boot when shim is removed.
- Sold separately: Single-slot cradle requires power supply [SKU# PWR-WUA5V12W0XX](#) (last XX of SKU are country-specific, [listed later in this document](#)) and USB-C cable [SKU# CBL-TC5X-USBC2A-01](#).



Single-slot USB / Ethernet charger cradle

SKU# CRD-TC2L-SE1ET-01

Single-slot charger and USB cradle. Charges a single device.

- Charges standard capacity battery from 0 to 80% in less than 1 hours 20 minutes.
- Charges extended capacity battery from 0 to 80% in less than 1 hours 50 minutes.
- Compatible with TC22 / TC27 units with hand straps, trigger handle or protective boot when shim is removed.
- Sold separately: Power supply [SKU# PWR-BGA12V50W0WW](#), DC cable [SKU# CBL-DC-388A1-01](#), and country-specific AC line cord ([listed later in this document](#)). To charge and sync using USB port with a computer, purchase USB cable [SKU# 25-124330-01R](#). To connect to Ethernet, purchase USB-to-Ethernet module [SKU# MOD-MT2-EU1-01](#) with bracket [SKU# BRKT-TC51-ENET1-02](#).



Single-slot device and battery charger cradle

SKU# CRD-TC2L-BS11B-01

Single-slot charger charges a TC22 / TC27 device and its spare Li-Ion battery.

- Charges Standard battery in device from 0 to 80% in less than 1 hour 20 minutes.
- Charges Extended battery in device from 0 to 80% in less than 1 hour 50 minutes.
- Compatible with TC22 / TC27 units with hand strap, trigger handle, or protective boot when shim is removed.
- Sold separately: Power supply [SKU# PWR-BGA12V50W0WW](#), DC cable [SKU# CBL-DC-388A1-01](#), and country-specific AC line cord ([listed later in this document](#)).

Multi-slot cradles

Five-slot charger cradle

SKU# CRD-TC2L-BS5CO-01

Multi-slot cradle to charge up to five TC22 / TC27 devices.

- Charges Standard Capacity battery from 0 to 80% in less than 1 hour 20 minutes.
- Charges Extended Capacity battery from 0 to 80% in less than 1 hour 50 minutes.
- Compatible with TC22 / TC27 units with hand straps, trigger handle, or protective boot when shim is removed.
- Can be rack-mounted in a standard 19-inch server rack via mounting bracket [SKU# BRKT-SCRD-SMRK-01](#).
- Sold separately: Power supply [SKU# PWR-BGA12V108W0WW](#), DC cable [SKU# CBL-DC-381A1-01](#), and country-specific AC line cord ([listed later in this document](#)).



Five-slot charge / Ethernet cradle

SKU# CRD-TC2L-SE5ET-01

Five-slot charge / Ethernet cradle. Charges five devices with network speeds of up to 1Gbps.

- Charges Standard Capacity battery from 0 to 80% in less than 1 hour 20 minutes.
- Charges Extended Capacity battery from 0 to 80% in less than 1 hour 50 minutes.
- Compatible with TC22 / TC27 units with hand straps, trigger handle, or protective boot when shim is removed.
- Can be rack-mounted in a standard 19-inch server rack via mounting bracket [SKU# BRKT-SCRD-SMRK-01](#).
- Sold separately: Power supply [SKU# PWR-BGA12V108W0WW](#), DC cable [SKU# CBL-DC-381A1-01](#), and country-specific AC line cord ([listed later in this document](#)).



Cradle cups

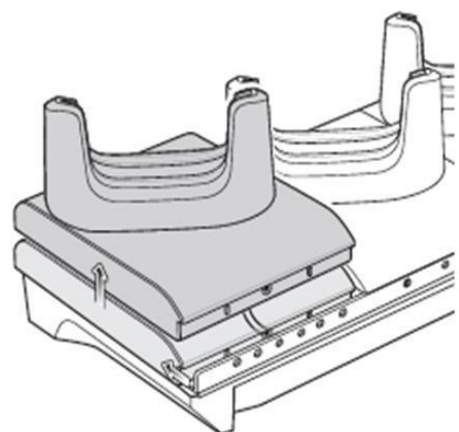

Device cradle cup replacement kit

SKU# CRDCUP-TC2L1C-01

One TC22 / TC27 device cradle cup replacement kit. Can be used to replace another device's cup purchased after 2019 on ShareCradle when upgrading to TC22 / TC27.

- Also available as a 5-pack — 5 device cradle cups — SKU# CRDCUP-TC2L5C-01.
- Not all five cups need to be used, therefore creating a multi-slot cradle supporting a mixed combination of devices (e.g., two TC22 / TC27 and three TC5X devices).

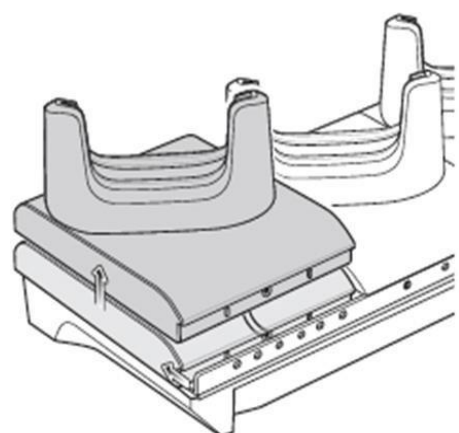

Charge and communication device cradle cup replacement kit

SKU# CRDCUP-TC2L1E-01

One TC22 / TC27 charge and USB / Ethernet connection device cradle cup replacement kit. Can be used to replace another device's cup purchased after 2019 on ShareCradle when upgrading to TC22 / TC27.

- Also available as a 5-pack — 5 device cradle cups — SKU# CRDCUP-TC2L5C-01.
- Not all five cups need to be used, therefore creating a multi-slot cradle supporting a mixed combination of devices (e.g., two TC22 / TC27 and three TC5X devices).

Mounting options for chargers



Rack mounting for space optimization

Optimize available space by mounting any set of five-slot chargers for TC22 / TC27 on a standard, 19-inch server rack.

- Ideal for customers that have several devices per location.
- Compatible with all five-slot chargers for TC22 / TC27.



Mounting bracket

SKU# BRKT-SCRD-SMRK-01

Use five-slot ShareCradle mounting bracket to attach five-slot TC22 / TC27 cradles to the wall or mount on a 19-inch server rack.

- Offers cable routing slots and removable tray that stores / conceals power supply.
- Adjustable orientations:
 - 25° angle for high-density (five-slot chargers).
 - Horizontal (single-slot or four-slot spare Li-ion charger).
- Four 4-slot spare battery chargers can be mounted as shown with mounting bracket.
- Use to mount to wall or with standard 19-inch server rack for more density and save space.

Spare Li-on batteries

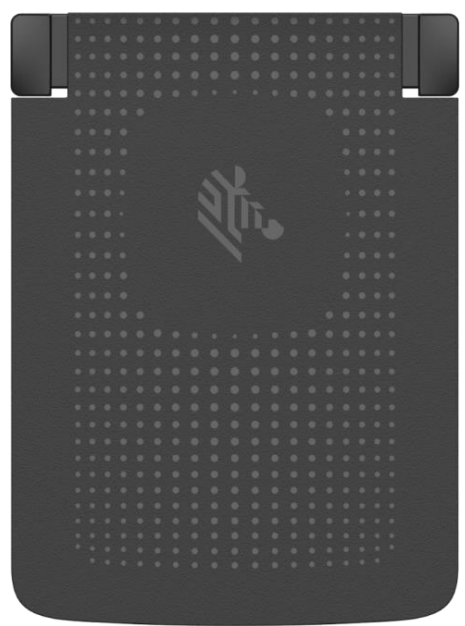

Standard Li-ion Bluetooth Battery with PowerPrecision

SKU# BTRY-TC2L-2XMAXB-01

Standard capacity 3,800mAh PowerPrecision Li-Ion Battery with BLE Beacon.

- Premium-grade battery cells with longer lifecycle and tested to meet rigorous controls and standards.
- BLE beacon allows device with this battery to be located even if powered off using [Zebra Device Tracker](#).
- Sold separately: Zebra Device Tracker licenses for either 1-year SKU# SW-BLE-DT-SP- 1YR or 3-years SKU# SW-BLE-DT-SP-3YR.

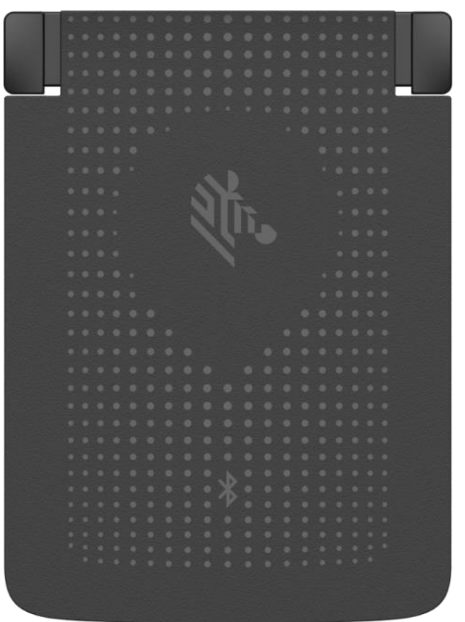

Standard Li-ion Battery with PowerPrecision

SKU# BTRY-TC2L-2XMAXX-01

Standard capacity 3,800 mAh PowerPrecision Li-ion Battery.

- Premium-grade battery cells with longer lifecycle and tested to meet rigorous controls and standards.



Extended PowerPrecision Li-ion Battery

SKU# BTRY-TC2L-3XMAXX-01

Extended capacity 5,200 mAh PowerPrecision Li-ion battery.

- Premium-grade battery cells with longer lifecycle and tested to meet rigorous controls and standards.

Spare battery chargers



Battery Charger

SKU# SAC-TC2L-4SCHG-01

Spare battery charger to charge any four Li-ion batteries.

- Charges Standard Capacity battery from 0 to 90% in less than 3 hours.
- Charges Extended Capacity battery from 0 to 90% in less than 4 hours..
- Can be used standalone or up to 4 chargers can be mounted on Mounting Bracket SKU# BRKT-SCRD-SMRK-01.
- Sold separately: Power Supply SKU# PWR-BGA12V50W0WW, DC Cable SKU# CBL-DC- 388A1-01, and Country-specific AC Line cord ([listed later in this document](#)).



Battery charger replacement kit

SKU# CRDCUP-TC2L4B-01

Four-slot battery charger replacement cup.

- Used to replace a legacy TC21 / TC26 series 4-slot Battery Charger on single-slot or multi-slot ShareCradle base when migrating from TC21 / TC26 to TC22 / TC27.
- No more than one cup shall be installed on a multi-slot ShareCradle base when converting with this 4-slot Battery Charger cup.
- Should replace the TC21/TC26 toaster cup in the same location on the ShareCradle base, usually the left-most slot when facing the cradle.

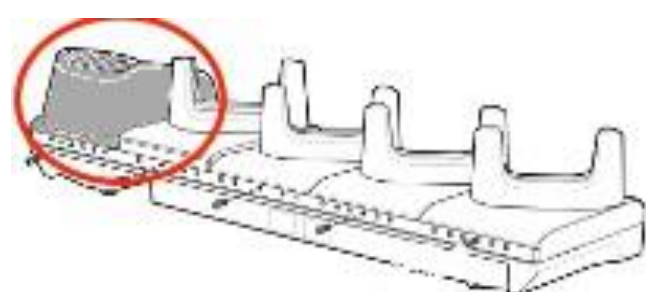

Accessories that power devices



Power supply, cables, and adaptors

Power supply and cable matrix













SKU#	Description	Note
PWR-BGA12V108W0WW	Level VI AC/DC power supply brick. AC Input: 100–240V, 2.8A. DC Output: 12V, 9A, 108W.	Sold separately. Use for: <ul style="list-style-type: none"> • CRD-TC2L-BS5CO-01 • CRD-TC2L-SE5ET-01
CBL-DC-381A1-01	DC line cord for running multi-slot cradles from a single Level VI power supply.	
PWR-BGA12V50W0WW	Level VI AC/DC power supply brick. AC Input: 100-240V, 2.4A. DC Output: 12V, 4.16A, 50W.	Sold separately. Use for: <ul style="list-style-type: none"> • CRD-TC2L-SE1ET-01 • CRD-TC2L-BS11B-01 • SAC-TC2L-4SCHG-01
CBL-DC-388A1-01	DC line cord for running single-slot cradles or battery chargers from a single Level VI power supply.	
CBL-TC2X-USBC-01	USB-A to USB-C cable with an additional ferrite bead.	
KIT-PWR-12V50W	Power supply kit for single-slot cradle including Power Supply SKU# PWR-BGA12V50W0WW and DC line cord SKU# CBL-DC-388A1-01 .	Sold separately: Country-specific AC line cord.
CBL-DC-382A1-01	DC line cord for running five-slot cradles when using Level VI Efficiency power supply SKU# PWR-BGA12V108W0WW . Includes black extension tab for releasing the cable.	
CBL-TC5X-USBC2A-01	USB C to USB A communications and charging cable, 1m long	Sold separately. Use to: <ul style="list-style-type: none"> • Directly charge TC22 / TC27 using a wall wart • Connect TC22 / TC27 to a computer (developer tools) • Charge TC22 / TC27 in a vehicle (can be used with cigarette light adapter SKU# CHG-AUTO-USB1-01, if needed)
CBL-TC2Y-USBC90A-01	USB C to USB A cable with 90° bend in USB-C adapter	
25-124330-01R	Micro USB active-sync cable for use with Single Slot USB/Communication Cradle.	Sold separately. Required for use with SKU# CRD-TC2L-SE1ET-01 if syncing with a computer is desired while TC22 / TC27 is in the charger.
CBL-DC-523A1-01	DC Y-line cord for running two 4-slot battery chargers to a single Level VI power supply SKU# PWR-BGA12V108W0WW .	Sold separately. Use to: Consolidate power supplies for multiple spare battery chargers proximally placed to each other.
PWR-WUA5V12W0XX	USB type A power supply adaptor (wall wart). Replace 'XX' in SKU as follows to get the right plug style based on region: US (United States) • GB (United Kingdom) • EU (European Union) AU (Australia) • CN (China) • IN (India) • KR (Korea) • BR (Brazil)	Sold separately. Use with a communications & charge cable to directly charge TC22 / TC27 device drawing power from a wall socket.

Accessories that power devices



Power supply, cables, and adaptors

Country-specific AC line cords: grounded, 3-prong

SKU#	Country / region	Note	
23844-00-00R	North America (United States, Canada, Mexico)	7.5 feet long Commonly used with chargers mounted in server racks	
50-16000-678R	North America (United States, Canada, Mexico)	3 feet long	
50-16000-221R	North America (United States, Canada, Mexico)	6 feet long	
50-16000-727R	Brazil	1.8 meters (6 feet) long	
50-16000-680R	Argentina	1.8 meters (6 feet) long	
50-16000-217R	American Samoa, Australia, New Guinea	1.8 meters (6 feet) long	
50-16000-218R	Japan	1.8 meters (6 feet) long	
50-16000-219R	Antigua, Bermuda, Burma, Channel Islands, Hong Kong, Iraq, Ireland, Malaysia, North Ireland, Scotland, Singapore, United Kingdom, Wales	1.8 meters (6 feet) long	
50-16000-257R	China	1.8 meters (6 feet) long	
50-16000-220R	Europe, Abu Dhabi, Bolivia, Dubai, Egypt, Iran, Korea, Russia, Vietnam	1.8 meters (6 feet) long	
50-16000-671R	Italy	1.8 meters (6 feet) long	
50-16000-669R	India, S. Africa, Africa	1.8 meters (6 feet) long	
			

Power supply, cables, and adaptors

Country-specific AC line cords: ungrounded, 2-prong

SKU#	Country / region	Note
50-16000-182R	United States	Type A NEMA 1-15 plug
50-16000-255R	Europe, Abu Dhabi, Bolivia, Dubai, Egypt, Iran, Korea, Russia, Vietnam.	Type C CEE7/16 plug
50-16000-670R	Bermuda, Hong Kong, Iraq, Ireland, Malaysia, Singapore, United Kingdom.	



Accessories that enable productivity solutions



Headsets

Close gaps, Open possibilities with Workcloud Sync

Usher in a new era of transformation—one led by your frontline and powered by Zebra Workcloud Sync. One where communication and information flows freely and gaps between teams, workflows and data are closed.

With Workcloud Sync, hindered workers become effective problem solvers, contributing their best. Critical workflows are streamlined in one place, on one device, equipping workers with the information they need, right at their fingertips.

Only Zebra offers the most complete lineup of software and rugged hardware with the scalability, support and service needed to make the greatest impact where it counts—on the frontline.

[Learn more about you can elevate your frontline workers with Zebra Workcloud Sync.](#)



Wired headsets for Workcloud Sync

SKU# HDST-USBC-PTT1-01

PTT headset with USB-C connector; one-piece solution.

- For Push-To-Talk (PTT) applications with volume up/volume down/PTT buttons. Compatible with PTT Express/PTT Pro.
- Rotating earpiece allows for right or left ear configuration. Mono headset with microphone.
- Includes clip for attaching PTT button to clothing.



Wired headsets for Workcloud Sync

SKU# HDST-35MM-PTVP-02

PTT and VoIP headset with 3.5mm standard jack.

- For Push-To-Talk (PTT) and VoIP telephony. Compatible with PTT Express/PTT Pro.
- Rotating earpiece allows for right or left ear configuration. Mono headset with microphone.
- Includes clip for attaching PTT button to clothing.
- Requires adapter **SKU# ADP-USBC-35MM1-01**.

Headsets

Rugged Bluetooth and corded HD voice headsets for the most demanding industrial environments

When it comes to enabling speech-driven applications and voice communications in warehouses, manufacturing plants and outdoor yards, you need a headset that is specially designed for the job. The HS3100 Bluetooth and HS2100 corded headsets are loaded with features that offer everything you need in an industrial headset.

Wired headsets for voice-directed picking

HS2100 rugged wired headset

Corded HD voice headset. Can be used with TC22/TC27 devices with adapters [SKU# CBL-HS2100-3MS1-01](#) and [SKU# ADP-USBC-35MM1-01](#).

- Dustproof, spray proof, and waterproof.
- Noise cancellation for a superior voice experience in the noisiest environments.
- Swiveling boom mutes microphone allowing user to prevent voice pick applications from recognizing non-voice pick conversations.
- Feather-light for extraordinary comfort.



SKU#	Description
HS2100-OTH	HS2100 Rugged Wired Headset Over-The-Head Headband includes HS2100 Boom Module and HSX100 OTH Headband Module
HS2100-BTN-L	HS2100 Rugged Wired Headset (Behind-the-neck headband left)
HS2100-OTH-SB	HS2100 Rugged Wired Headset (Over-the-head headband) includes HS2100 Shortened Boom Module and HSX100 OTH headband module
HS2100-BTN-LSB	HS2100 Rugged Wired Headset (Behind-the-neck headband left) includes HS2100 Shortened Boom Module and HSX100 BTN headband module

Wireless headsets for voice-directed picking

HS3100 rugged Bluetooth headset

Bluetooth headset for voice-directed picking applications.

- Noise cancellation tuned for Voice-Directed Picking applications.
- Swap batteries on the fly — without losing the Bluetooth connection.
- Split-second tap-to-pair simplicity using NFC. 15 hours of battery power.



SKU#	Description
HS3100-OTH	HS3100 Bluetooth Headset Over-The-Head Headband includes HS3100 Boom Module and HSX100 OTH Headband Module
HS3100-BTN-L	HS3100 Bluetooth Headset (Behind-the-neck headband left)
HS3100-OTH-SB	HS3100 Bluetooth Headset (Over-the-head headband) includes HS3100 Shortened Boom Module and HSX100 OTH headband module
HS3100-BTN-LSB	HS3100 Bluetooth Headset (Behind-the-neck headband left) includes HS3100 Shortened Boom Module and HSX100 BTN headband module
HS3100-SBOOM-01	HS3100 Shortened Boom Module (includes microphone boom, battery and windscreen)

Accessories that enable productivity solutions



Cables and adapters



Cigarette lighter adapter plug

SKU# CHG-AUTO-USB1-01

USB cigarette lighter adapter plug.

- Used with USB C Cable [SKU# CBL-TC5X-USBC2A-01](#) (sold separately) to provide in-vehicle charging.
- Includes two USB-A ports providing higher current (5V, 2.5A) for faster charging.



HS2100 Standard cable

SKU# CBL-HS2100-3MS1-01

HS2100 headset standard cable – 3.5mm jack.

- 3.5mm barrel jack connector with cable length 43 inches or 1.1 meters.
- For use with TC22 / TC27 or other devices using a 3.5mm barrel jack audio connector. Requires [SKU# ADP-USBC-35MM1-01](#).
- Rugged cable with rugged connectors that are keyed / collared for a locking failsafe connection.
- Includes one clothing clip. Additional clips can be purchased separately.



Adapter cable

SKU# ADP-USBC-35MM1-01

USB-C to 3.5mm adapter cable.

- Allows headsets with 3.5mm jack to be connected to TC22/TC27.
- Adapter provides push-to-talk (PTT) button, volume up / down buttons.
- Adapter cable length is about 2.5 feet or 78 centimeters.
- Clip on rear of adapter allows cable to be wrapped for length management
- PTT button functionality tested with headset [SKU# HDST-35MM-PTVP-02](#) where both the PTT button the headset and the adapter may be used.

Arm / wrist mounts



Arm mount with medium size length strap

SKU# SG-TC2L-ARMNT-01

Arm mount with medium size length strap.

- Enables the TC22 / TC27 to be mounted to the arm for hands free operation and can be used with the RS5100 / RS6100 (or similar) ring scanner.
- Compatible with Standard or Extended Capacity battery.
- Not compatible with Rugged Boot.
- Includes: Medium length (30cm or 12 inches) Velcro wrist strap [SKU# SG-TC2L-ARMSTRAP-01](#) and carrier comfort pad [SKU# SG-TC2L-CMPD-01](#)

** Please note this accessory is a consumable and may require replacement during the device's lifespan.*



Arm mount with large size length strap

SKU# SG-TC2L-ARMNT-02

Arm mount with large size length strap.

- Enables the TC22 / TC27 to be mounted to the arm for hands free operation and can be used with the RS5100 / RS6100 (or similar) ring scanner.
- Compatible with Standard or Extended Capacity battery.
- Not compatible with Rugged Boot.
- Includes: Large sized (33cm or 13 inches) Velcro wrist strap [SKU# SG-TC2L-ARMSTRAP-02](#) and carrier comfort pad [SKU# SG-TC2L-CMPD-01](#)

** Please note this accessory is a consumable and may require replacement during the device's lifespan.*



Arm mount with extended length strap

SKU# SG-TC2L-WMADP1-02

- Wrist mount with extended BOA dial-to-fit wrist strap
- Swivel design allows device to be viewed in portrait or landscape mode enabling hands- free functionality.
- Velcro-free design uses non-absorbent materials that can be wiped down.
- Strap length can be adjusted between 164 to 265mm (approx. 6.5 to 10.5")
- Not compatible with Rugged Boot.
- Includes: Carrier, Comfort Pad [SKU# SG-TC2L-CMPD-01](#) and medium / large sized wrist strap [SKU# SG-NGWT-WSTPLN-01](#)

** Please note this accessory is a consumable and may require replacement during the device's lifespan.*

Replacement straps and arm sleeve



BOA Replacement wrist strap

SKU# SG-NGWT-WSTPST-01

Replacement wrist strap – standard size.

- White dial and accent color on strap identify size as standard (small / medium).
- Strap length can be adjusted between 128 to 191mm (approx. 5.0 to 7.5").

** Please note this accessory is a consumable and may require replacement during the device's lifespan.*



BOA Replacement wrist strap

SKU# SG-NGWT-WSTPLN-01

Replacement wrist strap – extended size.

- Black dial and accent color on strap identify size as extended (medium / large).
- Strap length can be adjusted between 164 to 265mm (approx. 6.5 to 10.5").

** Please note this accessory is a consumable and may require replacement during the device's lifespan.*



BOA Replacement wrist strap

SKU# SG-NGWT-WSTPXL-01

Replacement wrist strap – extra-large size.

- Blue dial and accent color on strap identify size as extra-large.
- Strap length can be adjusted between 218 to 375 mm (approx. 8.5 to 14.75").

** Please note this accessory is a consumable and may require replacement during the device's lifespan.*



Arm sleeve

SKU# SG-WT4027050-01R

Arm sleeve – pack of 5.

- Worn under wrist mount strap if worker is in short-sleeved shirt and wants extra sweat wicking / personal layer, comfort and slip-resistance
- Material will not snag. One size fits all.
- Washable in mild detergent. Should be air dried.

** Please note this accessory is a consumable and may require replacement during the device's lifespan.*

Replacement straps, hand strap, and comfort pad

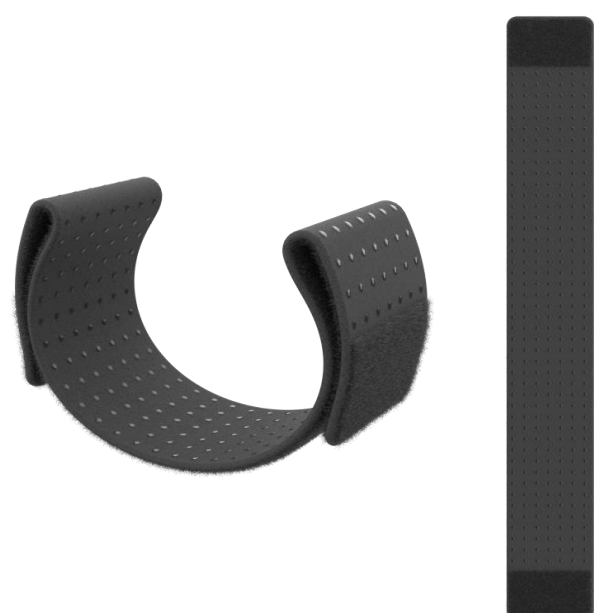

Medium Velcro Replacement Strap

SKU# SG-TC2L-ARMSTRAP-01

Replacement arm strap – size medium.

- Replaces the Velcro strap included for SKU# SG-TC2L-ARMNT-01
- Comes in size large with strap length of 300mm or 12"

** Please note this accessory is a consumable and may require replacement during the device's lifespan.*



Large Velcro Replacement Strap

SKU# SG-TC2L-ARMSTRAP-02

Replacement arm strap – size large.

- Replaces the Velcro strap included for SKU# SG-TC2L-ARMNT-02
- Comes in size large with strap length of 330mm or 13"

** Please note this accessory is a consumable and may require replacement during the device's lifespan.*



Hand strap

SKU# SG-TC2L-HSTRP1-01

Hand strap.

- Allows device to be easily held in palm of hand.
- Attaches directly to device, even with rugged boot installed.
- Sold separately: Rugged boot SKU# SG-TC2L-BOOT-01.

** Please note this accessory is a consumable and may require replacement during the device's lifespan.*

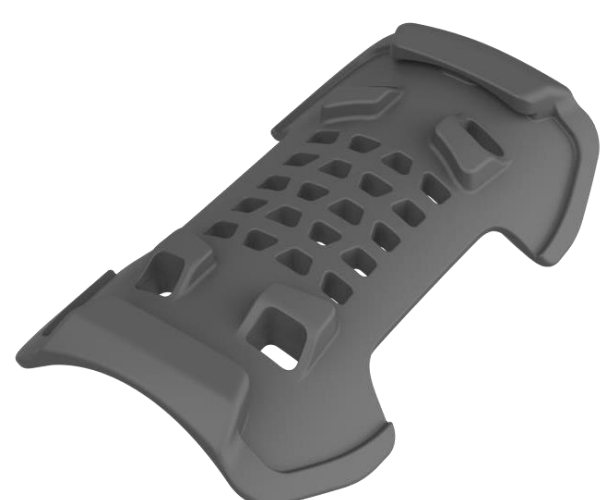

Replacement Comfort Pad

SKU# SG-TC2L-CMPD-01

Comfort Pad for Arm Mount

- Replaces the Comfort Pad included on either SKU# SG-TC2L- ARMNT-01 or SKU# SG-TC2L-ARMNT-02 or SKU# SG-TC2L- WMADP1-02.
- Soft Rubber material.
- Easily removable and hygienic.

** Please note this accessory is a consumable and may require replacement during the device's lifespan.*

Stylus and tether



Stylus

SKU# [SG-STYLUS-TCX-MTL-03](#)

Fiber tipped stylus – pack of 3.

- Heavy-duty and made from stainless steel / brass. No plastic parts — real pen feel. Can be used in rain.
- Micro-knit, hybrid-mesh, fiber tip provides silent, smooth gliding use. 5" length.
- Big improvement over rubber tipped or plastic tipped stylus.
- Compatible with all capacitive touch screen devices.
- Tether to device or hand strap using [SKU# SG-TC5NGTC7NG-TETHR-03](#).

** Please note this accessory is a consumable and may require replacement during the device's lifespan.*



Stylus tether

SKU# [SG-TC5NGTC7NG-TETHR-03](#)

Stylus tether.

- Can be attached to device tower bar.
- String type tether prevents loss of stylus.
- This tether is recommended when using Fiber Tipped Stylus (SG-STYLUS-TCX-MTL-03).

** Please note this accessory is a consumable and may require replacement during the device's lifespan.*

Trigger handles and accessories



Electronic trigger handle

SKU# TRG-TC2L-SNP1-01

Pistol-grip trigger handle.

- Uses electrical trigger via contacts on back side of TC22 / TC27.
- Trigger handle accessory offers customers the option of using the product in a gun form factor, ideal for scan-intensive operations.
- Requires rugged boot [SKU# SG-TC2L-BOOT-01](#).
- Does not block access to rear facing camera and flash allowing camera to be used while using the trigger handle.
- Compatible with both standard and extended capacity batteries.
- Not compatible with Hand Strap,



Wrist Strap

SKU# 50-12500-066

- Attaches to bottom of Snap-on Trigger Handle ([SKU# TRG-TC2L-SNP1-01](#)).

** Please note this accessory is a consumable and may require replacement during the device's lifespan.*

Soft holsters, rugged boots, and screen protectors



Rugged boot

SKU# SG-TC2L-BOOT-01

Rugged protective boot.

- Boot increases drop spec of device to 5 ft. (1.5 m) and drop surface to concrete.
- Compatible with devices using Standard or Extended Capacity battery.
- Compatible with Hand Strap.

** Please note this accessory is a consumable and may require replacement during the device's lifespan.*



Screen protector

SKU# SG-TC2L-SCRNPT1-01

Screen protector.

- Tempered glass.
- Includes: Alcohol wipes, cleaning cloth, and instructions needed for screen protector installation.

** Please note this accessory is a consumable and may require replacement during the device's lifespan.*



Soft holster

SKU# SG-TC2L-HLSTR1-01

Soft holster.

- Vertical orientation with open bucket design to accommodate TC22 / TC27 with optional trigger handle SKU# TRG-TC2L-SNP1-01 .
- Compatible with rugged boot SKU# SG-TC2L-BOOT-01 and hand strap SKU# SG-TC2L-HSTRP1-01.
- Opening at bottom of holster for providing drainage and route for audio from device's speaker.
- Nonrotating for maximum durability.
- Compatible with devices using Standard or Extended Capacity battery.

** Please note this accessory is a consumable and may require replacement during the device's lifespan.*

Workstation Connect Cradle



TC22 and TC27 Connect Cradle

Introducing the new **Connect Cradles** (Workstation and Point of Sale) for TC22 and T27 mobile computers. These accessories allow for the TC22 and TC27 mobile computer to connect to multiple purpose-built peripherals and enable Zebra Workstation Connect on an external monitor. The Connect Cradle offers connections for standard workstation setups (monitor, keyboard, mouse) while the point-of-sale configuration provides three additional powered USB ports for setups utilizing POS-specific peripherals such as a payment terminal, receipt printer, or scanner.



Connect Cradles

SKU# CRD-TC2L-1SNWS-01 | SKU# CRD-TC2L-1SNHP-01

Workstation | Point of Sale

- Workstation (SKU #CRD-TC2L-1SNWS-01): This connect cradle, allows users to use TC22 and TC27 device as a workstation or kiosk. Includes HDMI, Ethernet, USB-A (x4) ports, shims, and 3.5mm headset jack. Power supply, DC line cord and AC line cord are all sold separately.
- Point of Sale (SKU# CRD-TC2L-1SNHP-01): This connect cradle allows users to use the TC22 and TC27 devices as a Point of Sale terminal. Includes HDMI, Ethernet, USB-A (x3), 24V Powered USB (x1), 12V Powered USB (x2) ports, shims, and 3.5mm headset jack. Power supply and AC line cord are all sold separately.

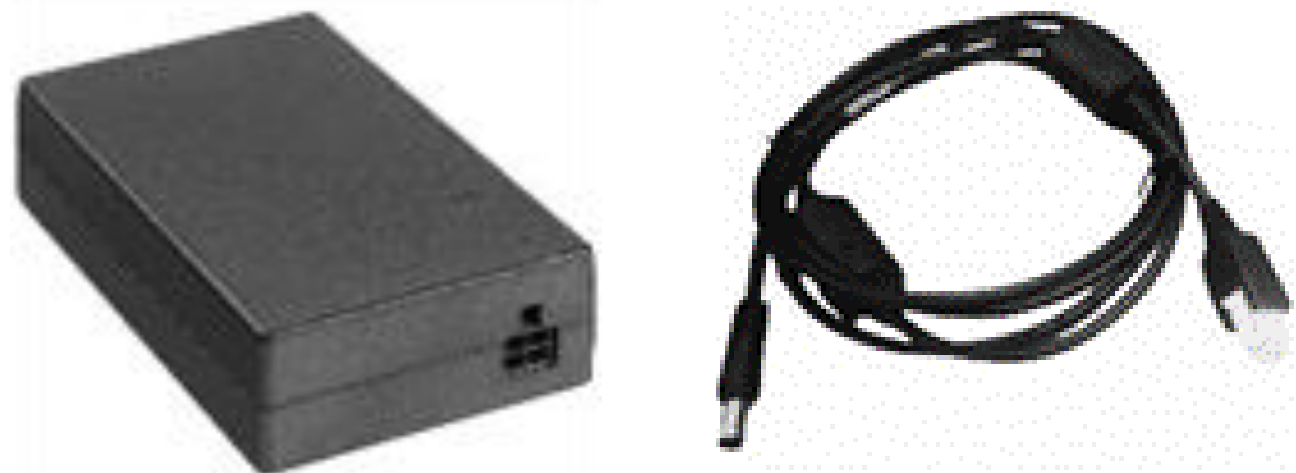

Power Supply & DC Line Cord for Workstation Connect Cradle

SKU# PWR-BGA12V50W0WW | SKU# CBL-DC-388A2-01

Power Supply | DC Line Cord

- Power Supply PWR-BGA12V50W0WW for Connect Cradle : 100-240 VAC, 12VDC, 4.16A.
- DC Line Cord CBL-DC-388A2-01 for above power supply: 12 VDC, 4.16A 1.8m length.
- Requires: Country Specific AC grounded line cord.



Power Supply for Point-of-Sale Cradle

SKU# PWR-BGA24V150W1WW

Power Supply for POS Cradle

- Level VI AC/DC Power Supply Brick. AC Input: 100-240V, 2.0A. DC Output: 24V, 6.25A, 150W.
- Requires: Country Specific AC grounded line cord.

Third Party Accessories for TC22 and TC27

Note: Products sold that do not bear the Zebra brand name are serviced and supported exclusively by their manufacturers in accordance with terms and conditions packaged with the products. Zebra's Limited Warranty does not apply to products that are not Zebra branded, even if packaged or sold with Zebra products. Please contact the manufacturer directly for technical support and customer service.



Purpose-Built Mounts™
For Zebra TC22/TC27

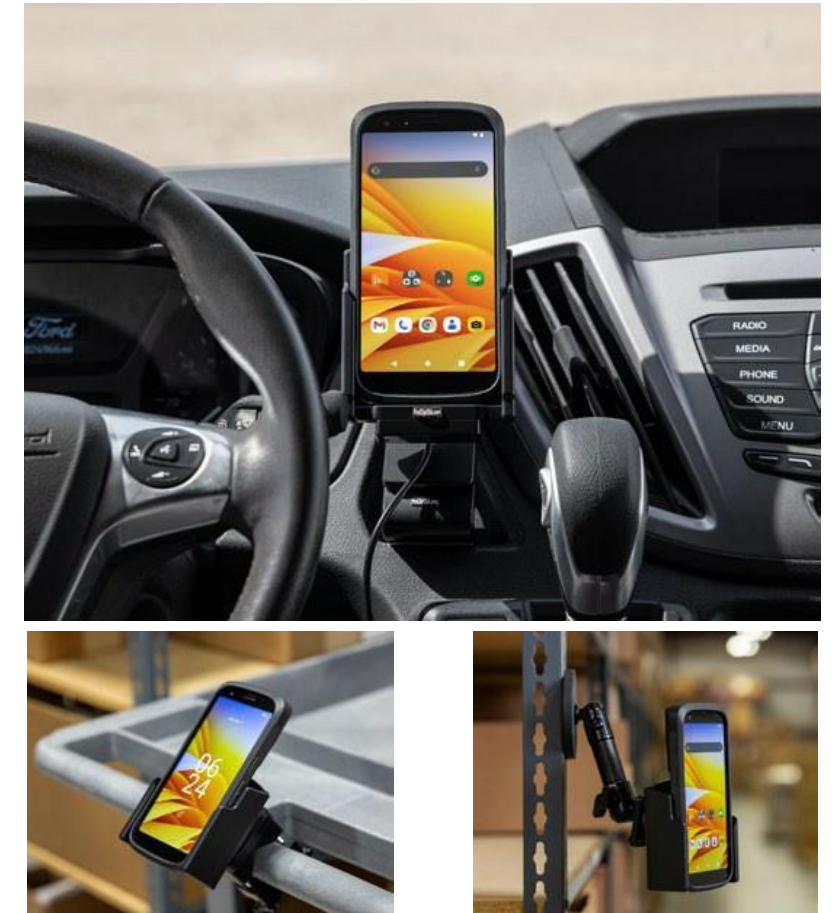

ProClip cradles provide:

- ✓ Easy one-handed docking and undocking
- ✓ Tilt-swivel gives users an optimized viewing angle
- ✓ Channeled sidewalls guide the device into the cradle and hold the device securely
- ✓ Heavy-duty construction provides protection and longevity
- ✓ Custom design to fit the device with or without the rugged boot



Part #	Description
3PTY-PCLIP-712348	Charging Cradle with Cigarette Lighter Plug for Zebra TC22 / TC27 with Rugged Boot
3PTY-PCLIP-712347	Charging Cradle with Cigarette Lighter Plug for Zebra TC22 / 27 (Bare Device)



Part #	Description
3PTY-PCLIP-713347	Charging Cradle with Hard-Wired Power Supply for Zebra TC22 / TC27 (Bare Device)
3PTY-PCLIP-713348	Charging Cradle with Hard-Wired Power Supply for Zebra TC22 / TC27 with Rugged Boot



Part #	Description
3PTY-PCLIP-711348	Non-Charging Cradle with Tilt-Swivel for Zebra TC22 / 27 with Rugged Boot
3PTY-PCLIP-711347	Non-Charging Cradle with Tilt-Swivel for Zebra TC22 / TC27 (Bare Device)



RAM® Form-Fit Docks

for Zebra TC22 / TC27 Handheld Computers

Protect your investment and stay hands-free in the field with RAM® Mounts spring-loaded docking solutions for the new Zebra TC22 & TC27 handheld computers. These docks are available with and without power, as well as non-locking and key-locking functions. Powered dock options offer a seamless experience by utilizing the device's pogo pad docking contacts and USB Type-A connector — simply dock the device to keep it charging. Pair with any modular RAM® Mounts components to create a custom mounting solution for your forklift, truck, pick cart and more!

Zebra TC22 / TC27 RAM® Mounts Docks				
PART NUMBER	KEY LOCK	USB TYPE-A POWER	FOR BOOT	
3PTY-RAM-HOL-ZE24U				
3PTY-RAM-HOL-ZE24LU	•			
3PTY-RAM-HOL-ZE24PU		•		
3PTY-RAM-HOL-ZE24PLU	•	•		
3PTY-RAM-HOL-ZE24-1U			•	
3PTY-RAM-HOL-ZE24L-1U	•		•	
3PTY-RAM-HOL-ZE24P-1U		•	•	
3PTY-RAM-HOL-ZE24PL-1U	•	•	•	
COMPATIBLE HARDWIRE CHARGER				
3PTY-RAM-GDS-CHARGE-V8BU GDS® 30-64V Hardwire Charger w/ USB Type-A				

Product Highlights



Pogo Pin Charging

Protect the charge port and increase efficiency utilizing the device's pogo pad docking contacts — simply dock the TC22/TC27 to keep the device charged. Each powered RAM® dock comes equipped with pogo pin technology for this seamless docking experience.



Removable Inserts

("-1U" Part Numbers Only)

Part numbers ending in "-1U" indicate docks that include removable inserts. When installed, these inserts retain form-fit docking of the TC22/TC27 when the rugged boot is removed from the device.



Stylus Holder

Integrated snap-in stylus holder on all docks prevent lost or dangling styluses when on-the-go.



Mount It

With RAM® Compatibility™ customize your mount to your environment. Our recommended mount is the RAM-101U Drill-Down mount.

Gamber-Johnson
**ZEBRA TC22/TC27 Cradles
& Mounting Accessories**



ZEBRA TC22/TC27 CRADLE

SKU# 3PTY-GJ-7160-1856

- Compatible with Zebra TC22/TC27 Handheld (Requires Zebra rugged boot)
- Cradle accommodates the Zebra TC22/TC27 hand strap.
- Adjustable cable restraint holds USB-C cord (not included) securely in place.
- Lightweight, small form factor designed to be resilient and reliable in harsh material handling and enterprise environments.
- Reduce costly damages by safely securing your device.
- Attaches to Gamber-Johnson mounting solutions using the AMPs hole pattern.



ZEBRA TC22/TC27 CRADLE W/ ZIRKONA MEDIUM JOINER MOUNT

SKU# 3PTY-GJ-7170-1016

Combine the Zebra TC22/TC27 handheld computer cradle with our Zirkona Medium Joiner to achieve a reliable and secure mounting solution.

- Kit includes Zebra TC22/TC27 Cradle (SKU# 3PTY-GJ-7160-1586)
- Designed for lightweight mounting.
- Round plates offer AMPS hole pattern to mount cradle, and to attach to a Gamber-Johnson dash mount or other AMPS mounting options.
- Quick adjust handle to easily adjust your device for optimal visibility.
- Zirkona Medium Joiner provides all axes range of motion in X axis (left/right), Y axis (front/back) and Z axis (up/down)
- All metal construction (anodized aluminum) will not deform or degrade.



ZEBRA TC22/TC27 CRADLE W/ ZIRKONA MEDIUM JOINER + SUCTION CUP MOUNT

SKU# 3PTY-GJ-7170-1017

Mount with confidence using the small suction cup from Zirkona. Combine the Zebra TC22/TC27 handheld computer cradle with our Zirkona medium joiner to achieve a reliable and secure mounting solution.

- Kit includes Zebra TC22/TC27 Cradle (SKU# 3PTY-GJ-7160-1586)
- Designed for lightweight mounting.
- Quick adjust handle to easily adjust your device for optimal visibility.
- Zirkona Medium Joiner provides all axes range of motion in X axis (left/right), Y axis (front/back) and Z axis (up/down)
- Small suction cup footprint of 3.5" creates a strong yet small mounting solution.
- Long handle provides ease of use when suctioning.
- Tacky surface on material helps with positioning your mount.

RUGGED BOOT FOR ZEBRA TC22-TC27

Increase the lifetime of your TC22-TC27 device by protecting it with the Mobilis rugged boot!

The TC22-TC27 Zebra is designed for intensive use in environments where drops and shocks are frequent. The Mobilis Protech case offers unbeatable protection :

Unbreakable : withstands 1000 drops from 1.20m/4ft.

Lightweight : thin, compact and discreet

Antimicrobial treatment : for impeccable hygiene

Eco-friendly : 30% recycled materials, 100% recyclable

Made in France : like all our PROTECH cases



Zebra Part number
3PTY-MOB-065022



AFNOR Cert. 102022

AIRCELL SYSTEM

4 air pockets to absorb shocks.
Up to **1000 drops from 1.20m/4ft**



HANDSTRAP READY

Compatible with
Mobilis Hand Strap

RESPONSIVE BUTTONS

High **tactile reactivity**



HOT SWAP BATTERY COMPATIBLE



ECO-CONCEPTION

Case made with
30% recycled material
& **100% recyclable**

ADVANCED RAISED EDGES

Design to protect the screen and camera lens **in the event of falls**



COMPATIBLE DOCKING INSERTS/SHIM ZEBRA

Compatible with ZEBRA charging stations :
CRD-TC2L-BS1CO-01 / CRD-TC2L-BS11B-01 / CRD-TC2L-SE1ET-01

Compatible with ZEBRA multiple charging stations :
CRD-TC2L-SE5ET-01 / CRD-TC2L-BS5CO-01

Compatible extended battery ZEBRA :
BTRY-TC2L-3XMAXX-01



RUGGED BOOT FOR ZEBRA TC22-TC27



Weight : 24 g | Dimensions : 138 x 82 x 33 mm

BOOST YOUR BRAND VISIBILITY!

Customize your protective boots with your colors and logo.



ADDITIONAL PRODUCTS



Handstrap
3PTY-MOB-001367



Screen Protector TC22
3PTY-MOB-036302



Holster Size M
3PTY-MOB-031002



Pack of 10 capacitive stylus
with spiral cord
3PTY-MOB-001054



Universal Wrist Mount
Armband 5-7'' - HHD
3PTY-MOB-030004

SPECIFICATIONS

Ref	Product
3PTY-MOB-065022	RUGGED BOOT ZEBRA TC22-TC27



EXPLORE OUR
ZEBRA PRODUCTS

CONTACT :

✉ Imebrouki@mobiliscase.com
☎ +33 682 005 064
💻 datacapture.mobiliscase.com

