



# KDC1000/1100 Quick Guide



### Contents

- 1. Product Concept..... 3
  - 1.1 What is KDC1000/1100 about? ..... 3
  - 1.2 Key Design Concepts ..... 3
  - 1.3 Key Features..... 4
- 2. Product Introduction..... 5
  - 2.1 KDC1000/1100 Diagram ..... 5
  - 2.2 How to turn on and off ..... 5
  - 2.3 How to Install/Uninstall the Smart Device into the Integrated Case (Android/iOS) ..... 6
  - 2.4 How to Connect PC with KDC or Phone ..... 7
- 3. Connection method between KDC and Phone..... 8
  - 3.1 USB Serial Mode ..... 8
  - 3.2 USB HID Mode ..... 9
  - 3.3 Serial Mode ..... 10
  - 3.4 Bluetooth Mode..... 10
- 4. Bluetooth Pairing ..... 11
  - 4.1 Bluetooth Profiles Explained..... 11
  - 4.2 Bluetooth Pairing a KDC1000/1100 to your smart device with special barcodes ..... 11
- 5. Usage..... 13
  - 5.1 Using Keyboard Wedge (HID Keyboard) ..... 13
  - 5.2 Using KTSync – Android/iOS ..... 13
  - 5.3 Using KTSync Keyboard – Android..... 15
  - 5.4 Using KTSync Keyboard – iOS ..... 16
  - 5.5 Using other developed applications with SDK – Android/iOS..... 17
- 6. UHF Reader Companion ..... 18
  - 6.1 KDC1000/1100 1.0W UHF Reader Diagram ..... 18
  - 6.2 KDC1000/1100 0.5W UHF Reader Diagram ..... 19
- 7. UHF Reader Companion Usage..... 20
  - 7.1 Read RFID tag and Barcode with trigger: Trigger mode..... 20
  - 7.2 Toggling the Read Mode: Barcode Mode vs. UHF mode ..... 21
  - 7.3 Changing the UHF Read Tag Modes: Single, Multiple, or Active..... 21

7.4	UHF Tag Counting (Beep Count) .....	23
7.5	Phone Charging Option .....	24
7.6	UHF default options in HID mode and USB serial/BLE SPP mode .....	24
8.	KDCUHF Demo App (Tag Read/Write Demo) .....	25
8.1	Install demo application .....	25
8.2	Connect KDC with a smart device .....	25
8.3	Read UHF data .....	26
8.4	Select UHF tag .....	27
8.5	Read or Write UHF tag .....	28
8.6	SDK API .....	28
8.7	Lock UHF tag .....	29
8.8	Kill UHF tag .....	30
8.9	UHF Setting .....	31
8.10	Application setting .....	33
8.11	KDC Information .....	34
9.	Product Specifications .....	35
9.1	Base Scanner .....	35
9.2	1.0W UHF Reader .....	36
9.3	0.5W UHF Reader .....	36
10.	Appendix. Useful Special Barcodes .....	37
10.1	Scan Options .....	37
10.2	Scan Options .....	37
10.3	Data Process - Wedge/Store, Enter Key & Extend Key .....	37
10.4	Data Process – Data Edit .....	38
10.5	Data Process – Data Format and Handshake .....	38
10.6	Data Process – Termination Character & Duplicate Check .....	38
10.7	Bluetooth .....	39
10.8	HID Initial Delay .....	39
10.9	HID Character Delay .....	40
10.10	System .....	40
10.11	OTG/Bluetooth (Android & iPhone15) .....	41

## 1. Product Concept

### 1.1 What is KDC1000/1100 about?

This Barcode/Rfid/mPOS SmartSled is our most modular product yet. Whether you need to read barcodes or RFID tags this is the SmartSled for you. The KDC1000 and KDC1100 are rugged devices with an IP65 rating and are built to last. No matter what type of data you need to collect or how you need to collect it, there is a companion module to get the job done quickly and accurately. You can charge your device with our unique charging cases and never miss a minute of productivity. KDC1100 is an angled version of KDC1000, which provides a different scanning angle.

The KDC1000/1100 can be attached to select smart devices via a custom case to create a sled scanning solution. This unique modular design allows you to upgrade your smart device without worrying about replacing the entire scanning solution. Your investment in a KDC is protected regardless of upgrades in smartphone and tablet technology.

### 1.2 Key Design Concepts

#### a) Barcode Reading

At their base, the KDC1000 and KDC1100 are superior barcode scanners. The KDC1000 & KDC1100 are equipped with 2D Imagers, so you can read a variety of barcodes in any industry. Especially, the KDC1100 offers downward angled scan engines, allowing you to hold your device at level while scanning barcodes at a lower height. The KDC connects via USB or Serial or Bluetooth Low Energy technology for data transfers.

#### b) RFID Companions

RFID companions attach directly to your KDC creating a contactless radio frequency identification reader. The interface can be utilized for asset management and tracking whether those assets are people, animals, or inanimate objects. Options include High Frequency (HF), 0.5W Ultra High Frequency (UHF), or 1.0W UHF. Also, charging is easy with a Type-C USB connector or charging cradle for multiple devices.

#### c) Additional Companions

- Extended Battery Pack - For long shifts or projects. Never worry about the battery of your KDC or smart device.
- Pistol Grip - Pull the trigger for easy scanning.
- MSR (Magnetic Swipe Reader) Companion – payment through MSR card or membership management through loyalty card
- mPOS (Mobile POS) Companion – payment through Chip&Pin, MSR, and Contactless (NFC)

### 1.3 Key Features

- a) **Sled (SmartSled®)**
  - Supports select smartphones: Protect investment on Sled regardless of smartphone change.
  - Connects with smartphones via USB or Serial or Bluetooth.
  - IP65 rated and 5ft drop spec
- b) **Modular Design:** Supports various technologies and accessories below:
  - 1D and 2D Barcode Reader
  - HF or UHF RFID Reader
  - Extended Battery Pack
  - Pistol Grip
  - MSR & mPOS Companion
- c) **Custom Smart Case for simultaneous charging**
  - One USB charging port (or charging cradle) charges both KDC1000/1100 and smartphone.

## 2. Product Introduction

The KDC1000 Barcode scanning sled is a 2D Imager Barcode Data Collector supporting USB or Serial or Bluetooth Low Energy (BLE) v5.0.

The KDC1100 Barcode scanning sled is an angled version of KDC1000 with a 2D Imager scan engine.

### 2.1 KDC1000/1100 Diagram

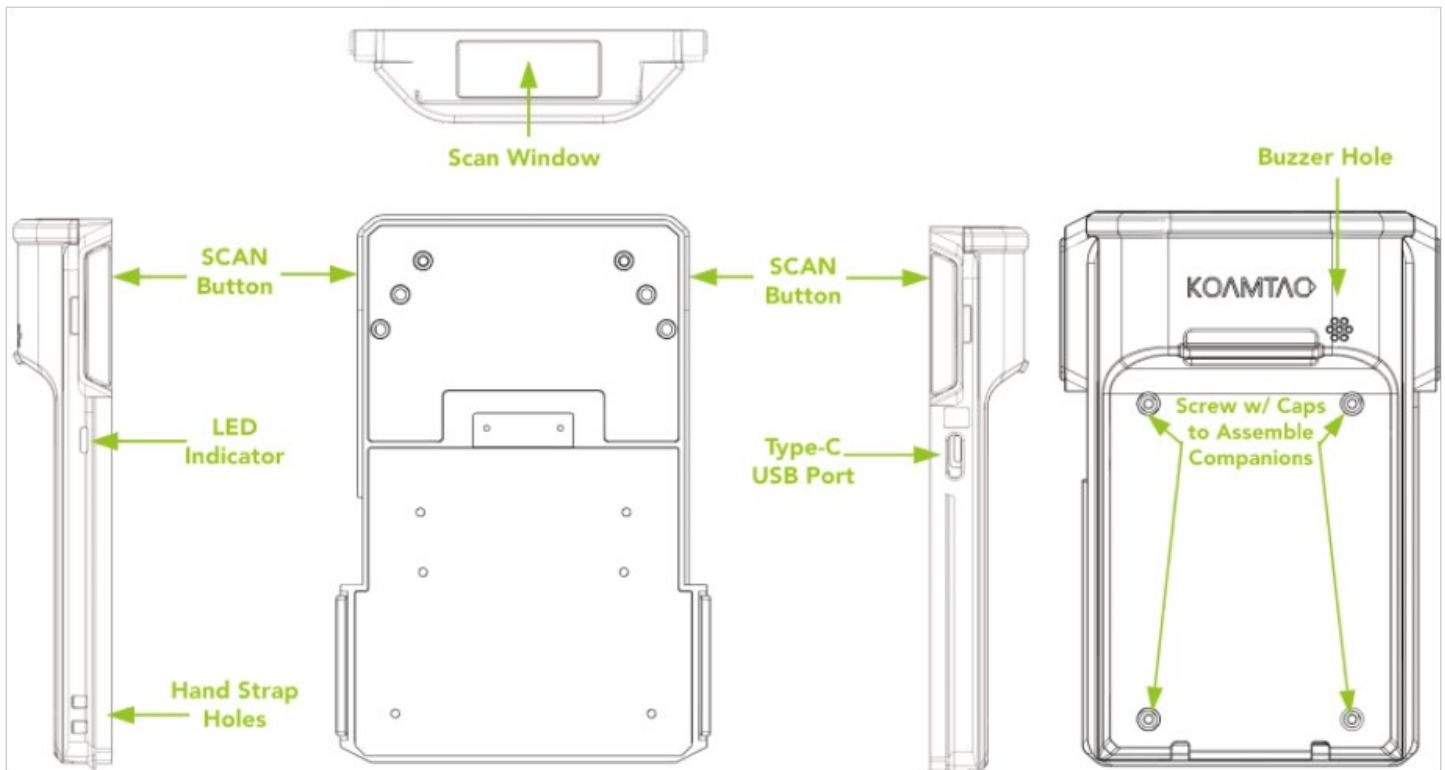

*\*KDC1100 is identical except for an angled scan window and scan engine*

### 2.2 How to turn on and off

Refer to the figure in section 1.1 to locate the SCAN buttons.

- Press and hold the left SCAN button and right SCAN button simultaneously for 3 seconds.
- The KDC will beep when it is turned ON.
- Press and hold the left SCAN button and right SCAN button simultaneously for 3 seconds again to turn off the KDC.

### 2.3 How to Install/Uninstall the Smart Device into the Integrated Case (Android/iOS)

To install the smart device, please follow the steps below.

- a) Bend back top of the SmartSled case.

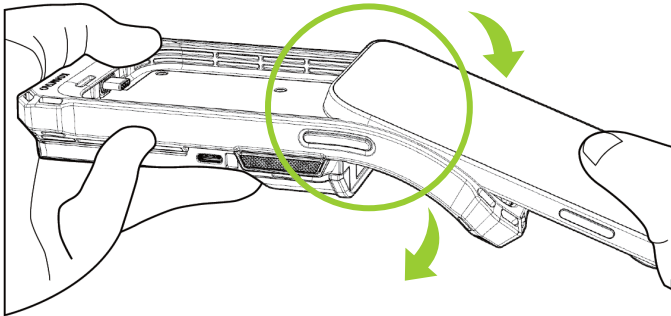

- b) Slide device into case toward connector.

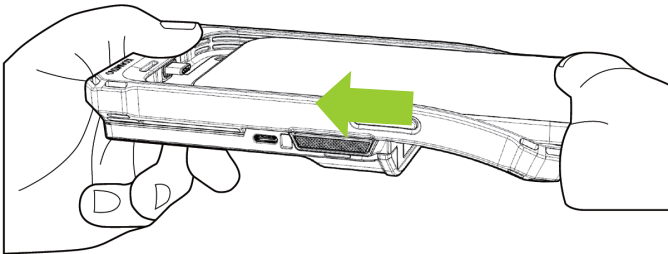

- c) Pull top of case over device.

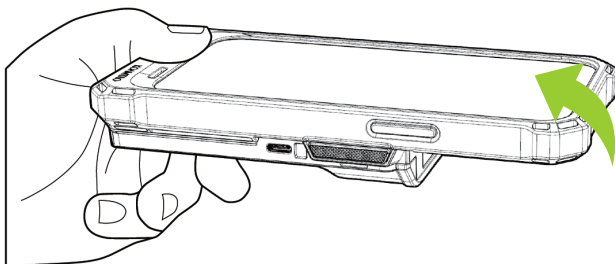

- d) To remove, carefully bend back top of SmartSled case (do not bend smart device) and slide device out.

### 2.4 How to Connect PC with KDC or Phone

The KDC1000/1100 automatically sets up a communication path with Phone when you plug smartphone in the case. When you need to use KTSync on PC or download new firmware into KDC from PC, you can connect to PC by scanning below barcode once connect USB cable from PC to KDC1000/1100 USB port located in the side.



If you want to connect PC with your phone without taking out the phone from the case, you can set it up by scanning below barcode. Then KDC1000/1100 bypasses the communication path to the phone from PC so that you can access the phone from PC.



To reconnect KDC1000/1100 to phone, scan below barcode.



### 3. Connection method between KDC and Phone

The KDC1000/1100 can communicate with Phone via USB or Serial or Bluetooth. By default, the KDC1000/1100 communicates via USB HID mode. If the phone is iPhone 13 or 14, the KDC1000/1100 communicates via Serial.

By default, the KDC1000/1100 is in USB OTG mode to communicate via USB or Serial. To communicate via Bluetooth, it is needed to change to Bluetooth Mode.

The following barcodes are USB OTG and Bluetooth Mode barcodes.

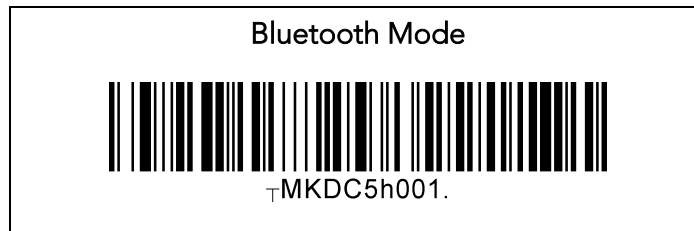
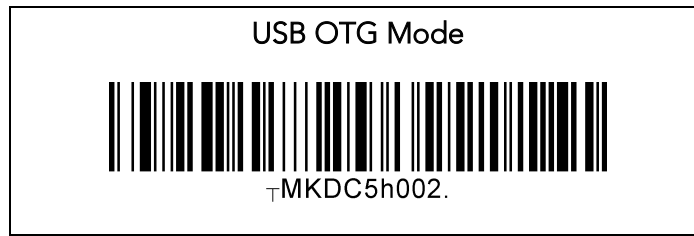

#### 3.1 USB Serial Mode

The KDC1000/1100 communicates with Android or iPhone 15 via USB Serial mode. There are two USB serial modes: USB CDC and USB MFi. USB CDC is for connecting to Android Phone and USB MFi for connecting to iPhone 15. The following barcodes are USB CDC and USB MFi selection barcodes.

USB CDC (Android)



USB MFi (iOS)



### 3.2 USB HID Mode

The KDC1000/1100 default mode is a USB HID mode when connected to Android and iPhone 15 phones. Once Phone is assembled into the KDC1000/1100, the KDC1000/1100 automatically works as a keyboard without any further setup. If you open any application with a text field and tap on the text field, then proceed to scan any barcode, you will notice that the barcode data will be populated into that text field. If you need to switch back into USB HID Mode from USB Serial Mode, scan this barcode:

USB HID



### 3.3 Serial Mode

The KDC1000/1100 automatically connects via Serial if iPhone 13 or 14 is connected. There is no specific barcode for this Serial communication. If you install phone into the case, Serial communication is automatically enabled. Serial communication is the only option iPhone 13 and 14 and does not support HID keyboard.

### 3.4 Bluetooth Mode

The KDC1000/1100 communicates with Phone via Bluetooth when Bluetooth Mode is selected. The KDC1000/1100 does support Bluetooth Low Energy V5.0.

### 4. Bluetooth Pairing



Connecting your KDC using Bluetooth is made easy with the pairing barcodes below:

#### 4.1 Bluetooth Profiles Explained

- HID Profile:** Allows one-way Bluetooth communication with an Android or iOS host device. The KDC only transmits data to the host device.
- SPP Profile:** Allows two-way Bluetooth communication. The KDC transmits data to the host device and the host device can transmit data back to the KDC.
- HID Windows Profile:** Allows one-way Bluetooth communication with a Windows PC. The KDC only transmits data to the Windows PC.

**Note:** HID inputs data directly into an application. SPP requires the KOAMTAC KTSync® app or integration of KOAMTAC SDK to input data into an application. To gain access to the SDK, please complete the form here: <https://www.koamtac.com/sdk/>

#### 4.2 Bluetooth Pairing a KDC1000/1100 to your smart device with special barcodes

Bluetooth Profile & Pairing	
#1. HID-BLE & Pairing (Android, iOS, Mac)	
#2. HID-Windows & Pairing (Windows)	
#3. SPP-BLE & Pairing (Android, iOS, Mac, Windows)	

- Navigate to the Bluetooth setting on the host device and ensure that Bluetooth is both enabled and searching for devices.
- Using the KDC, scan the pairing barcode above that corresponds to your desired Bluetooth profile.

- If you use an Android, iOS, or Mac device and desire an HID connection, then scan barcode #1 above.
  - If you use a Windows device and desire an HID connection, then scan barcode #2 above.
  - If you desire an SPP connection for any device, then scan barcode #3 above.
- c. In HID or HID Windows Profile, check the list of available Bluetooth devices on your host device. From the list, select the KDC1000/1100 listed by serial number in brackets that matches the serial number found on the side of the KDC1000/1100. KDC1000/1100 will beep upon connection. Now it is ready to use.
- d. In SPP Profile for non-iOS, check the list of available Bluetooth devices on your host device. From the list, select the KDC1000/1100 listed by serial number in brackets that matches the serial number found on the side of the KDC1000/1100. KDC1000/1100 will beep upon connection, but you should launch KTSync or your application and select KDC1000/1100 within the application to complete the connection. Now it is ready to use.
- e. In SPP Profile for iOS, the KDC is NOT listed on your host device, so you should launch KTSync or your application and select the KDC1000/1100 listed by serial number in brackets that matches the serial number found on the side of the KDC1000/1100. KDC1000/1100 will beep upon connection. Now it is ready to use.

## 5. Usage

### 5.1 Using Keyboard Wedge (HID Keyboard)

This option is only available when using the HID profile.

Once the KDC is paired with the host, open any application with a text field and tap on the text field. Scan any barcode and it will populate in the text field.

### 5.2 Using KTSync – Android/iOS

You can use KTSync to utilize your KDC alone or with a native application. This is only available using USB OTG (Android and iPhone 15), Serial (iPhone 13 & 14), or Bluetooth connection with SPP.

- Download and install KTSync from the [Google Play Store](#) or the [Apple App Store](#).
- Open KTSync and tap on the “Connect” option on the bottom left to view a list of available devices. (Fig. 1)
- In using Android, the pairing should be established from Settings of the phone and in case of iOS, “START BLE SCANNING” menu should be run from “Connect” menu.
- From the device list, select your KDC – ensuring that the serial number displayed in brackets matches the serial number on the side of your KDC. (Fig. 2)
- Upon successful connection, KTSync will display “Connected” next to the name of your KDC at the top of the application. (Fig. 3)
- To test your connection, scan any barcode. If the connection is successful, the barcode data will display on the screen. (Fig. 3)



< Fig. 1 >

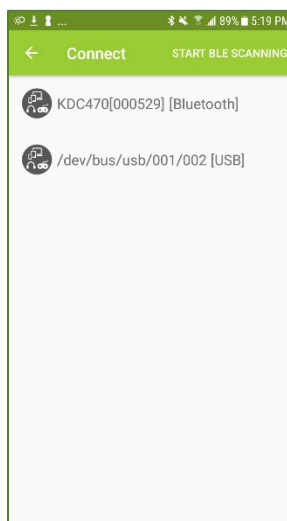

< Fig. 2 >

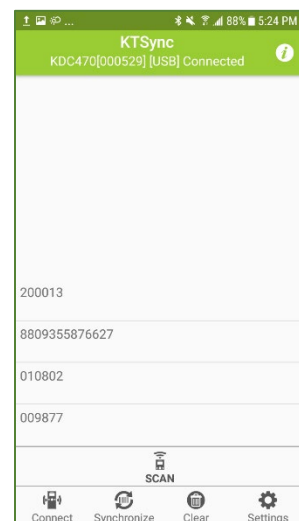

< Fig. 3 >

In Always-Pairing mode, an application can connect to a KDC without reading a pairing barcode, so the connection procedure is a little different.

- a) In the KTSync app, tap the Connect icon at the bottom left of the app.
- b) In KTSync, tap "START BLE SCANNING" in the top right.
- c) In KTSync, check the list of found devices.
- d) In KTSync, tap the KDC1000/1100 listed by serial number in brackets followed by [BLE] that matches the serial number found on the side of the KDC1000/1100. The format will look like this, KDC1000/1100[xxxxxx] [BLE], where xxxxxx is the serial number.
- e) The KDC1000/1100 will beep upon connection. Now it is ready to use.

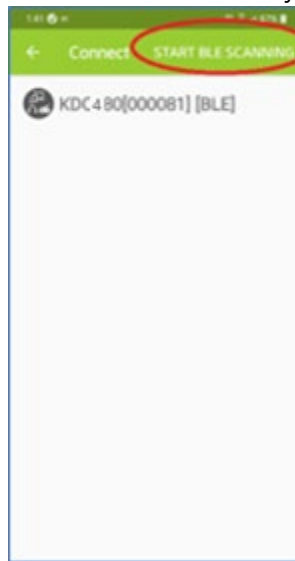

< Fig. 4 >

## 5.3 Using KTSync Keyboard – Android

Once your KDC is connected to KTSync, you can use your KDC as a keyboard.

- While KTSync is running in the background, navigate to Settings > Language & Input > Virtual Keyboard > Manage keyboards
- Tap on “KTSync Keyboard” to enable it.
- Change “KTSync Keyboard” to the default keyboard. (Fig. 5)

To switch back to the previous keyboard, simply change the default keyboard again. Or, when a text field is selected swipe down from the top of the screen to bring up the notification panel. Select ‘choose input method’ and you can select the default keyboard from here. (Fig. 6)

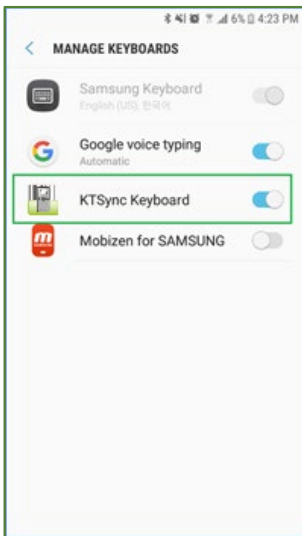

< Fig. 5 >

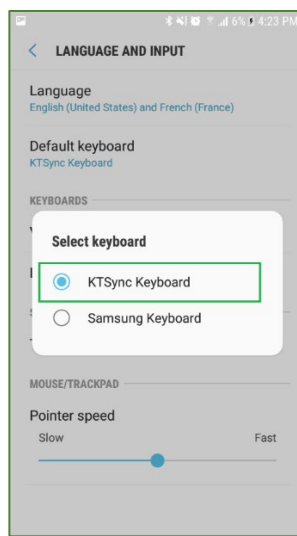

< Fig. 6 >

## 5.4 Using KTSync Keyboard – iOS

Once your KDC is connected to KTSync, you can use your KDC as a keyboard.

- Navigate to the Settings > General > Keyboard > Keyboards > Add New Keyboard... > Select the KTSync keyboard to be added. (Fig. 7)
- Select the KTSync Keyboard and toggle the switch to Allow Full Access. (Fig. 8)

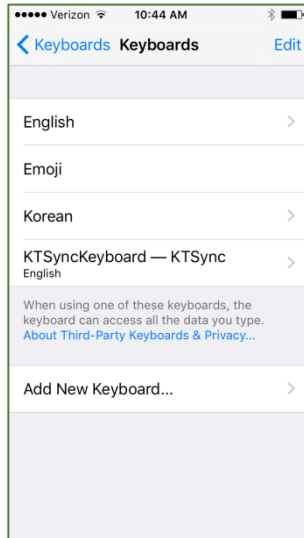

< Fig. 7 >

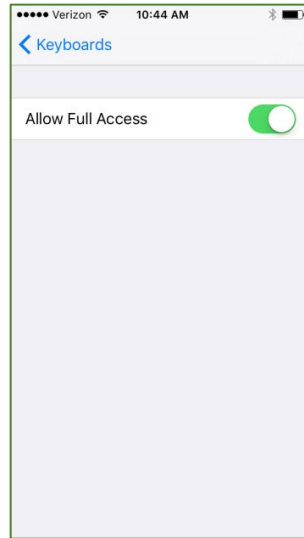

< Fig. 8 >

- Open the application you want to scan into and tap on the screen, so the on-screen keyboard appears.
- Press and hold the globe icon located to the left of the spacebar.
- Select the KTSync Keyboard and begin scanning. (Fig. 9)

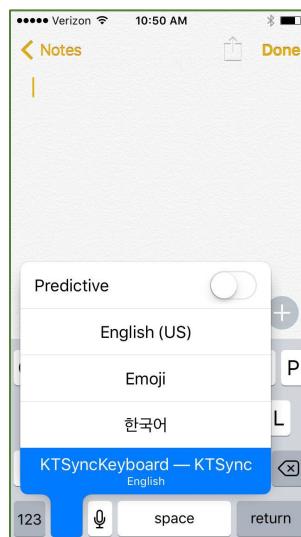

< Fig. 9 >

Note: The KDC must be connected to KTSync & the KTSync keyboard must be selected for this to work.

## 5.5 Using other developed applications with SDK – Android/iOS

A Software Development Kit (SDK) for Android and iOS is available to all KOAMTAC customers to ensure smooth development of applications that work seamlessly with a KDC scanner. It's easy to request the SDK from the KOAMTAC website:

- a) On any web browser, open [www.koamtac.com](http://www.koamtac.com)
- b) Navigate to SUPPORT > Downloads > [SDK](#)
- c) Complete the form and submit it.

After submission, a KOAMTAC representative will reach out regarding next steps for completing the SDK Agreement.

The SDK package will have libraries, documents, a sample application, and its source code.

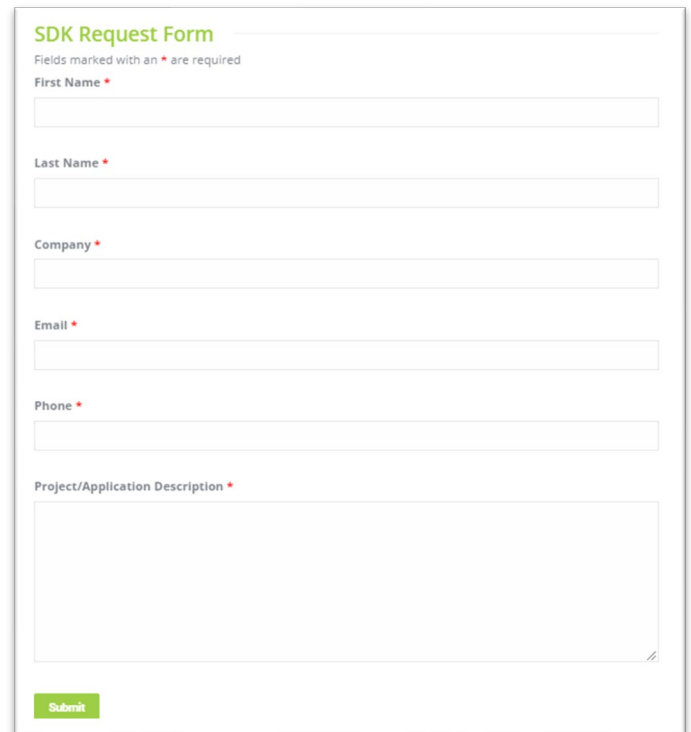

The screenshot shows a web form titled "SDK Request Form". At the top, it says "Fields marked with an \* are required". The form contains the following fields:

- First Name \*
- Last Name \*
- Company \*
- Email \*
- Phone \*
- Project/Application Description \*

At the bottom of the form is a green "Submit" button.

## 6. UHF Reader Companion

### 6.1 KDC1000/1100 1.0W UHF Reader Diagram

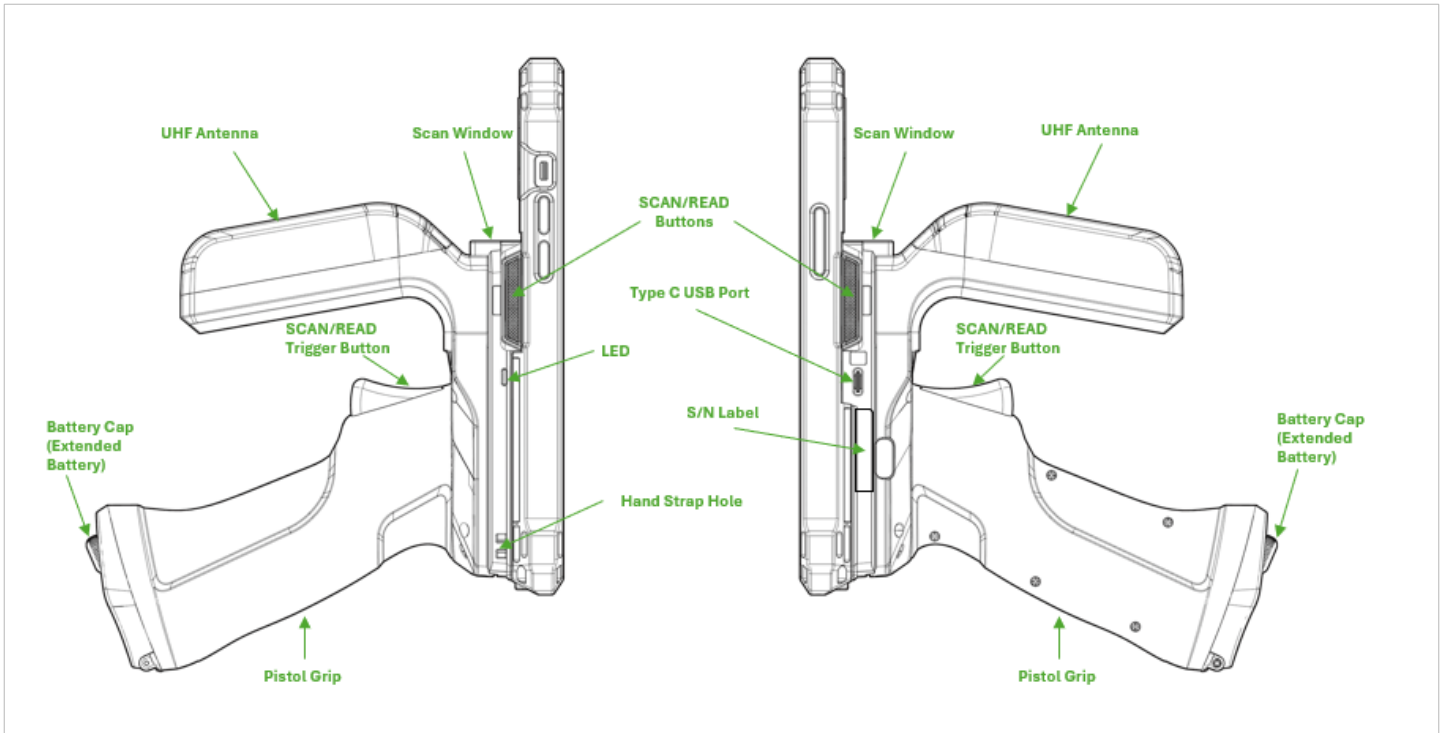

*\* 1.0W UHF Reader mounted to KDC1000*

## 6.2 KDC1000/1100 0.5W UHF Reader Diagram

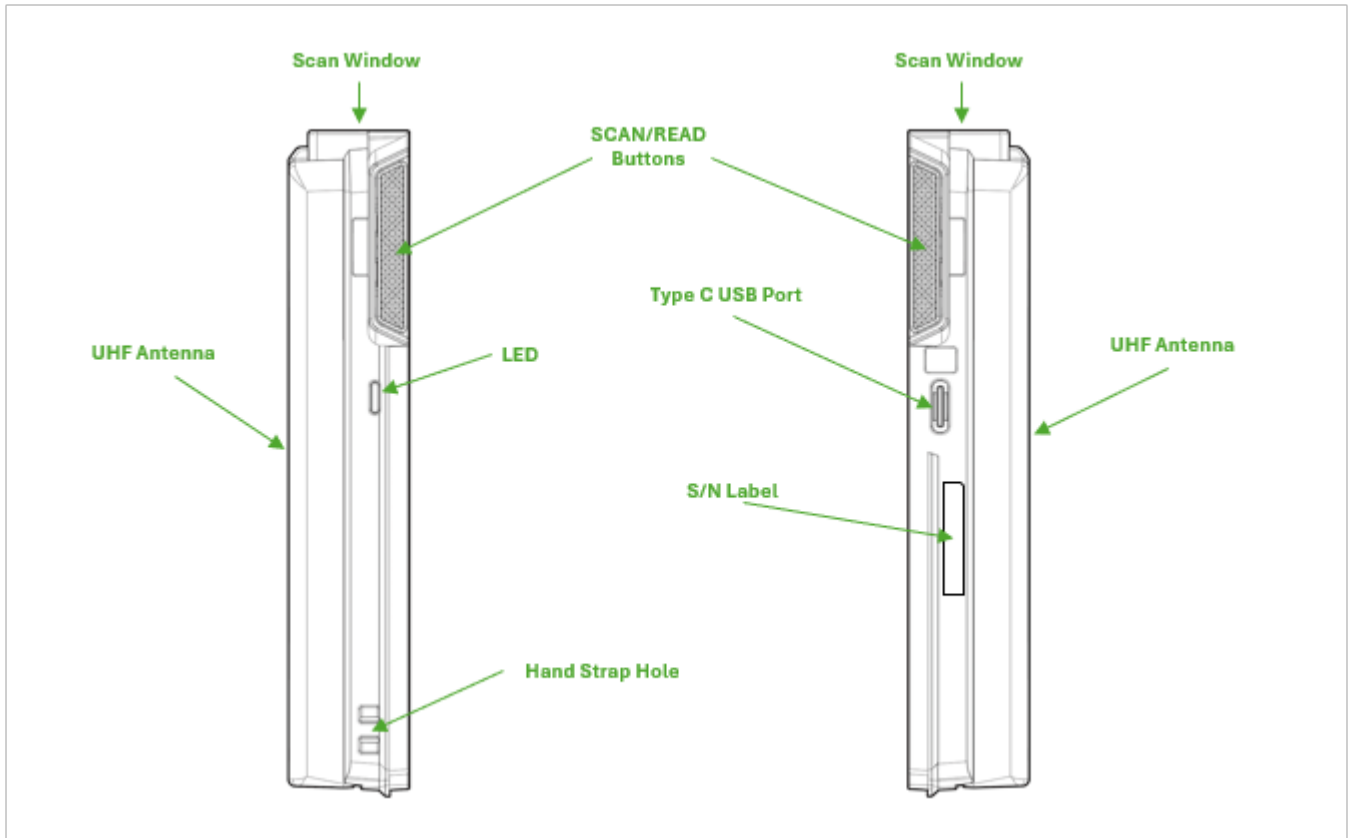

*\* 0.5W UHF Reader mounted to KDC1000*

## 7. UHF Reader Companion Usage

For optimal UHF tag read performance and to ensure that human exposure to RF energy does not exceed the FCC and European Union guidelines, always follow the instructions and precautions below:

- Before using the KDC1000/1100 UHF reader, the user should carefully read this operation guide and user guide to understand how to use KDC1000/1100 UHF reader properly.
- The KDC1000/1100 UHF reader should be used by a professional person who fully understands how to operate the KDC1000/1100 UHF reader.
- Maintain at least 20cm (about 8 inches) between the KDC1000/1100 UHF reader and the body when reading UHF RFID tags.
- Keep the KDC1000/1100 UHF antenna facing towards the UHF RFID tag. Do not direct the antenna towards the body when reading UHF RFID tags.
- Exit UHF tag read mode and enter Barcode read mode when finished reading UHF tags.
- Do not wear the KDC1000/1100 UHF reader when not using the KDC1000/1100 UHF reader.

### 7.1 Read RFID tag and Barcode with trigger: Trigger mode

In Trigger Mode, you can scan barcodes and UHF tags by pulling the trigger on the pistol grip of the 1W UHF Reader. Pulling the trigger once allows the KDC1000/1100 to read RFID tags, while pulling it twice in quick succession enables the KDC1000/1100 to scan barcodes.

The following are barcodes to enable/disable Trigger mode:



### 7.2 Toggling the Read Mode: Barcode Mode vs. UHF mode

With the same SCAN button or the trigger on the pistol grip of the 1W UHF Reader, you can read barcodes (Barcode mode) or UHF tags (UHF mode) depending on the read mode and you can change the mode alternatively.

- a) In "Barcode Mode", a barcode can be read by a SCAN button or trigger button.
- b) In "UHF Mode", UHF tags can be read by a SCAN button or trigger button.
- c) By default, the SmartSled is in "Barcode Mode". Also, it is set back to "Barcode Mode" after a factory reset.
- d) There are two ways to change the read mode:
  - 1) Press below combinations of SCAN button in 3 seconds.  
<Left Scan><Left Scan><Right Scan><Right Scan><Left Scan><Right Scan>
  - 2) Change from within the application using SDK
- e) When the mode is changed, the KDC will give a series of beeps to confirm the mode change:  
When you enter **UHF Mode**: 1 long and 2 short beeps  
When you enter **Barcode Mode**: 1 long and 1 short beep

### 7.3 Changing the UHF Read Tag Modes: Single, Multiple, or Active

This mode only works when the device is in UHF mode. Refer to 3.1 to see how to toggle read modes.

- **Single Mode**: Only one tag is read every time the scan button is pressed.
  - 1 short beep will occur when changing mode.
- **Multiple Mode**: When the Scan button is pressed, reads multiple tags simultaneously for the set time (default 10 seconds).
  - 2 short beeps will occur when changing mode.
  - Time setting can be changed in Settings ->Reading Timeout.
- **Active Mode**: Basic operation status. Simultaneous reading of multiple tags while pressing the scan button (max. 10 minutes)
  - 3 short beeps will occur when changing mode.

Scan the special barcodes to change the mode. To change from active mode to another mode, you should disable the active mode first.



In Active Mode, if the SCAN button or Trigger button is pressed more than 10 minutes, the read mode automatically changes from UHF Mode to Barcode Mode to save battery life in the case of the trigger being stuck in the scan position. This option is enabled by default and may be disabled.

If you need to scan with the trigger depressed for more than 10 minutes, you need to disable the Active Read 10 Minute Timeout.

### Active Read 10 Minute Timeout

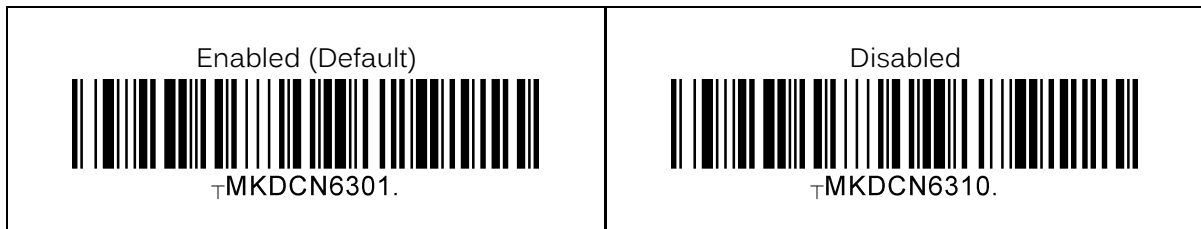

### 7.4 UHF Tag Counting (Beep Count)

By setting the Count attribute, you can get an estimate on how many tags are read per beep.

- Count = 0: The device only beeps once when you start reading
- Count = 5: Beeps once every 5 tags read. Example: 2 beeps means you read 10 to 14 tags.
- Count = 10: Beeps once every 10 tags read. Example: 2 beeps means you read 20 to 29 tags.
- Count = 20: Beeps once every 20 tags read. Example: 2 beeps means you read 40 to 59 tags.
- Count = 50: Beeps once every 50 tags read. Example: 2 beeps means you read 100 to 149 tags.

Scan the barcode on below that corresponds with your preference for Tag Counting.

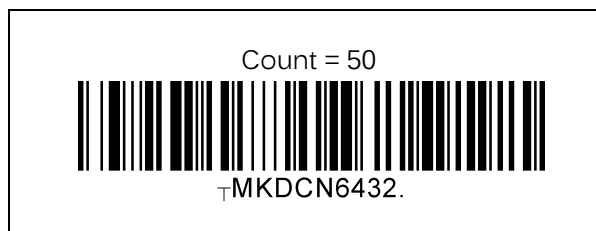
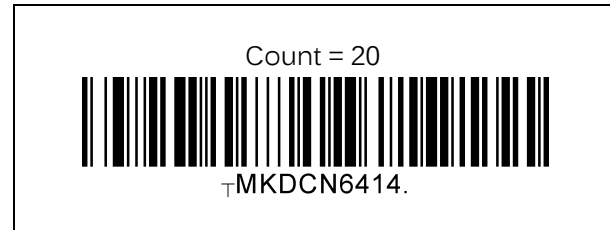
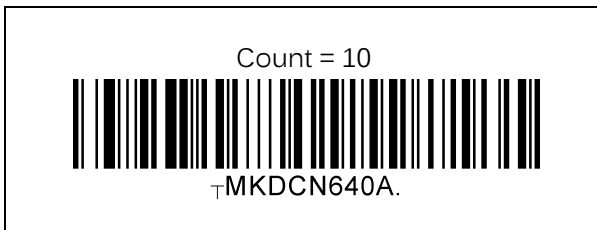
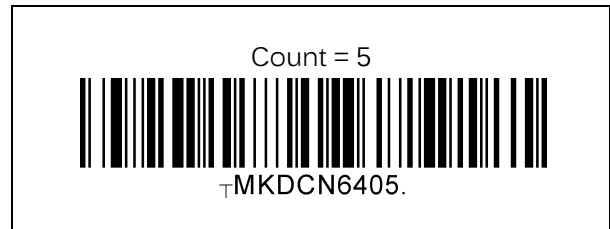
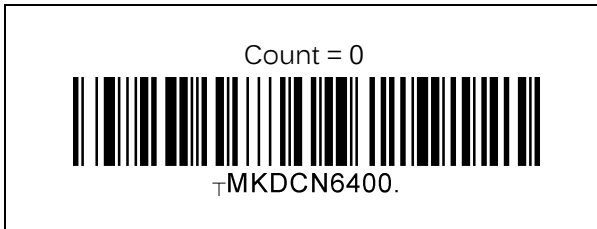

### 7.5 Phone Charging Option

This option allows the user the option to charge their phone via the extended battery contained inside the pistol grip.

- Enabled (Default): Phone charging from the extended battery is enabled.
- Disabled: Phone charging from the extended battery is disabled.



### 7.6 UHF default options in HID mode and USB serial/BLE SPP mode

The following options are default settings in HID mode.

- UHF Tag Read mode - 'Single Mode'.
- Burst mode - 'Disabled'.
- UHF Data Format - 'Hex'.
- UHF Start/Stop Key Event - 'Disabled'.

The following options are default settings in USB serial or BLE SPP mode.

- UHF Tag Read mode - 'Active Mode'.
- Burst mode - 'Enabled'.
- UHF Data Format - 'Binary'.
- UHF Start/Stop Key Event - 'Enabled'.

### 8. KDCUHF Demo App (Tag Read/Write Demo)

#### 8.1 Install demo application

1. You can download the demo application from Google Play Store or Apple App Store and install it: KDCUHF

#### 8.2 Connect KDC with a smart device

1. First, if you connect via Bluetooth, you should pair KDC with your host device through Bluetooth.
  - a. Send KDC to a pairing mode by scanning SPP & Pairing or MFi & Pairing barcode from the Quick Manual
  - b. Pair your smart device with KDC from the Bluetooth device list
  - c. See the [reference manual](#) for more detail pairing process.
2. Start KDCUHF you just installed then KDCUHF is trying to connect with KDC among paired KDC list.
3. If you want to connect to the specific KDC, please use the menu "Connect" from KDCUHF.

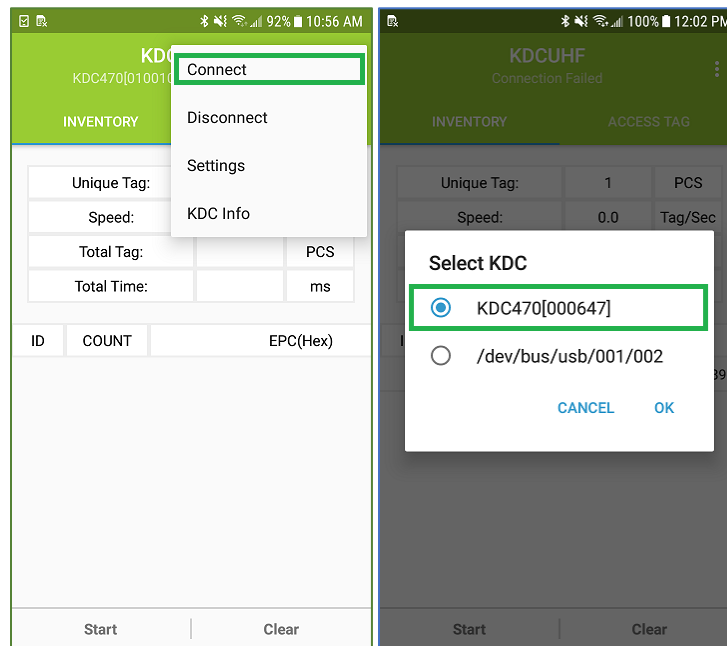

### 8.3 Read UHF data

1. Select "INVENTORY" and approach your UHF tags to read.
2. Then tap on "Start" button or press the physical SCAN button on the KDC.
3. You might hear multiple fast beeps while reading depending on the number of UHF tags nearby.
4. You can clear the current information with "Clear" button.

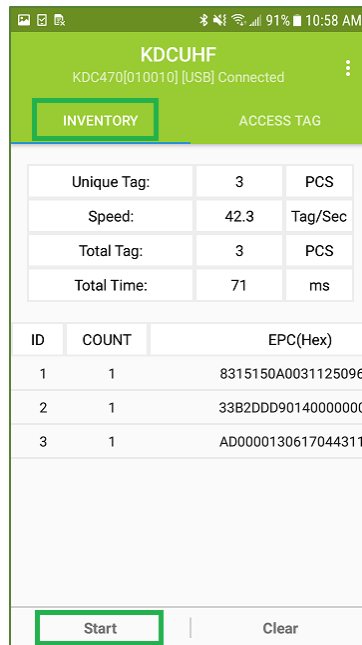

Unique Tag	The number of the unique tags which have been read.
Speed	The rate to identify tags, in pcs/s.
Total Tag	A piece of EPC No. The total amount which includes the data being repeatedly read.
Total Time	Total time it takes from start point, in ms.

Meaning of the data in EPC column as below:

ID	ID for identifying unique tags
COUNT	The number of read each tag
EPC	EPC data of read tag
PC	PC data of read tag

## 8.4 Select UHF tag

Scan tags nearby and select the tag which you want to work with.

1. Select "ACCESS TAG" to set up
2. Approach UHF tag to write and tap on "Refresh" then you'll see the tag information on the "Tag List" field if successful.
3. Also, you'll see the toast message at the bottom saying, "Getting Tag List Succeeded".
4. Choose one UHF tag to do manual operation and tap on "Select".
5. If successful, you'll see the toast message at the bottom saying, "Selecting Tag Succeeded".

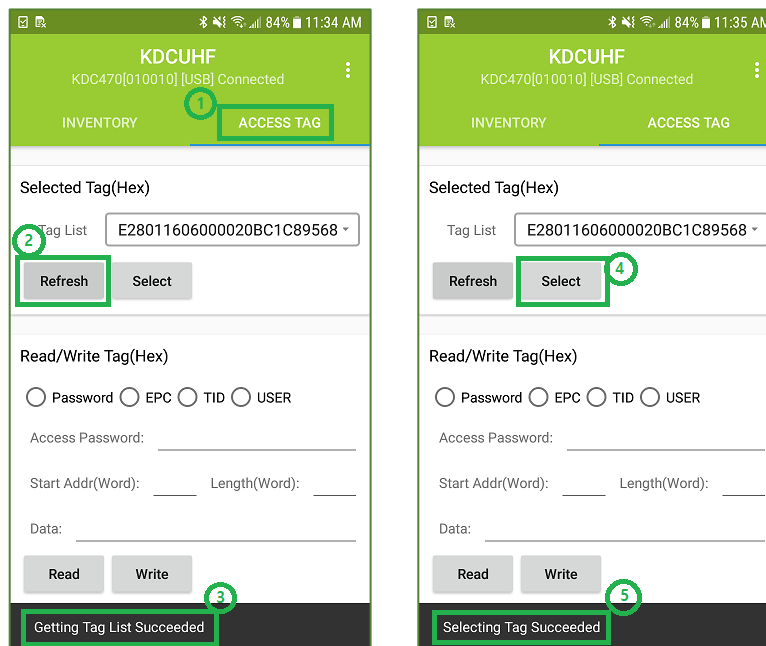

### 8.5 Read or Write UHF tag

#### Read Password and Read/Write data

1. Access password is required to read or write data. To get password, select "Password" and tap "Read" button.
  - KDCUHF uses the default access password (00 00 00 00) to get password. If the access password of the tag has been changed, the proper access password is required.
2. Once the password is read successfully, select the memory area to write (Password, EPC, or USER).
3. And then put the start address (Start Addr) and the length (Length), together with the data in hex to write (Data) and tap "Write" button.

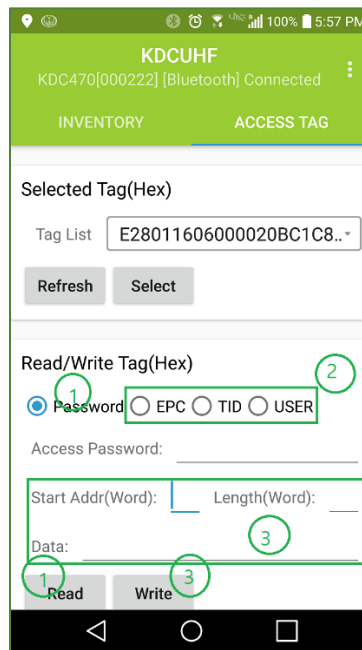

### 8.6 SDK API

1. The API to write a data to UHF tag is:  
`public boolean WriteUHFTagMemory(byte[] pwd, UHFMemoryBank bank, int start, int length, byte[] data, UHFStatus status)`
2. You can check the guide document in the SDK package: KDC SDK Guide for Android.pdf

See [Reference Manual](#) for more detailed information.  
 Visit [store.koamtac.com](http://store.koamtac.com) to purchase additional KDCs and accessories.

### 8.7 Lock UHF tag

Select UHF tag, Get access password and lock the tag.

1. Select UHF tag which you want to lock through "Select Tag" menu. If the tag is selected already, skip it.
2. Access password is required to proceed locking the tag.
  - It might be invalid to lock the tag with the default password. Please modify the access password first before locking
3. Choose memory bank and action (unlock, lock, permanent...) and tap "Lock" button on "Lock Tag" menu.

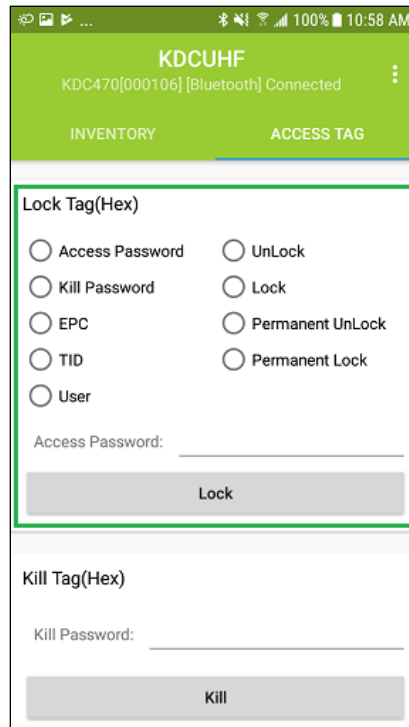

## 8.8 Kill UHF tag

Select UHF tag, Get kill password and kill the tag.

1. Select UHF tag which you want to kill through "Select Tag" menu. If the tag is selected already, skip it.
2. Kill password is required to proceed killing the tag.
  - It is not possible to kill tags with default kill password. Please modify the kill password first.
3. Tap "Kill" button on "Kill Tag" menu.
  - Killed tags are no longer available.

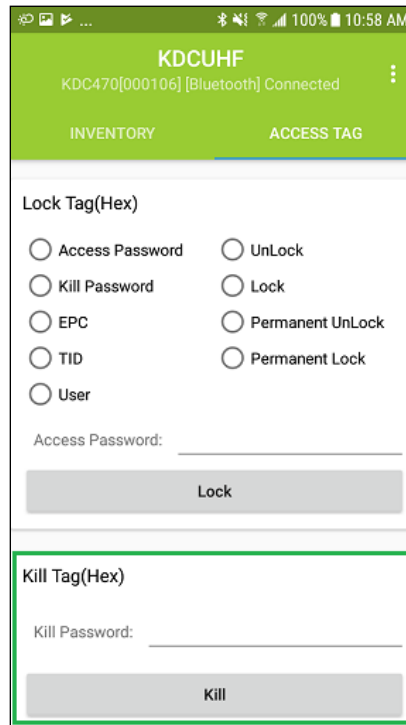

## 8.9 UHF Setting

Change the connected KDC UHF configurations.

### 1. Enable UHF Power

Determine whether UHF Power is on or off.

### 2. UHF Power Level

Set UHF Power Level to the specific dBm.

### 3. Enable Smart Hopping

Enable or Disable "Smart Hopping" function.

It is depended on KDC which you are using.

### 4. UHF Read Tag Mode

Select UHF Read Tag Mode.

Single – Read only one tag.

Multiple – Read tags for a specific time.

Active – Read tags during "Scan" button is pressed

### 5. UHF Reading Timeout

Set Reading Timeout for Multiple Read Tag Mode.

### 6. Enable Duplicate Check

If enabled, duplicated tag data is not sent by KDC.

### 7. UHF Read Mode

Determine whether to scan Barcode or UHF when a Scan button of KDC is pressed or a scan command is received from the application.

### 8. UHF Data Type

Select UHF Data Type. Received data is composed with EPC and PC or EPC only.

### 9. Set UHF Region

Set UHF bandwidth (Frequency, Power, ...) to fit the region.

It is depended on KDC which you are using.

### 10. Stop Active Read

"Active Read" function stops after a certain period of time.

### 11. RFID beep count

Select read beep count of KDC.

See [Reference Manual](#) for more detailed information.

Visit [store.koamtac.com](http://store.koamtac.com) to purchase additional KDCs and accessories.

### 12. Store RFID data

Determine whether read tag data is stored or not.

### 13. Charging Phone

Enable or Disable "Charging Phone" function when using 1.0W.

### 14. UHF ID

Show the UHF module ID

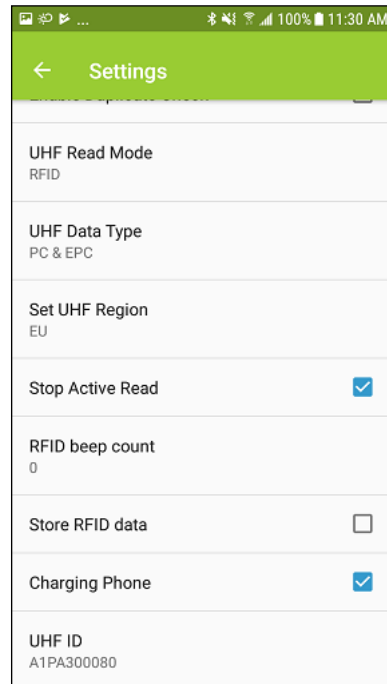
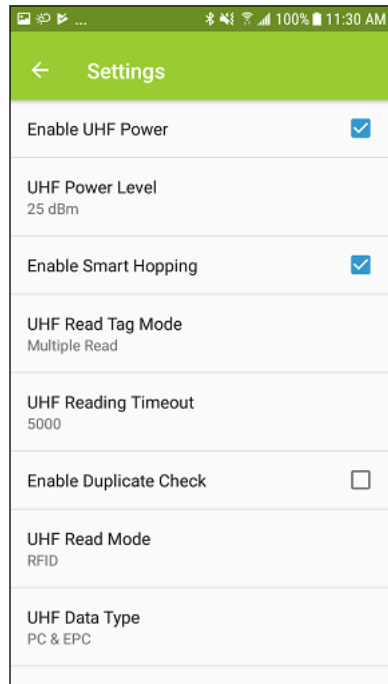

## 8.10 Application setting

Change KDC UHF configurations.

### 1. Display Data Format

- Select Hex string or ASCII as the default display data format.

When "Display Data Format" is ASCII,

"^" is used control character like "\" so you should write "^ ^", if you want to input "^" in ASCII mode.

Characters that can't be displayed are indicated by "^" and a two digit hex string. For example, 0x00 0xFF will be displayed ^00^FF.

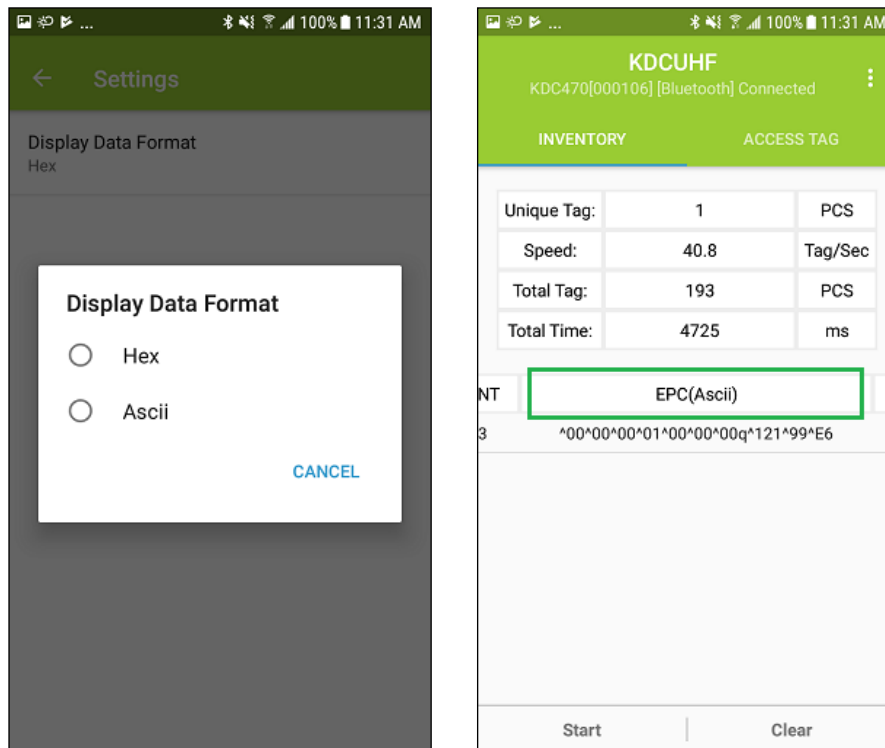

## 8.11 KDC Information

Display the connected KDC information.

- Serial Number, Firmware Version, etc.

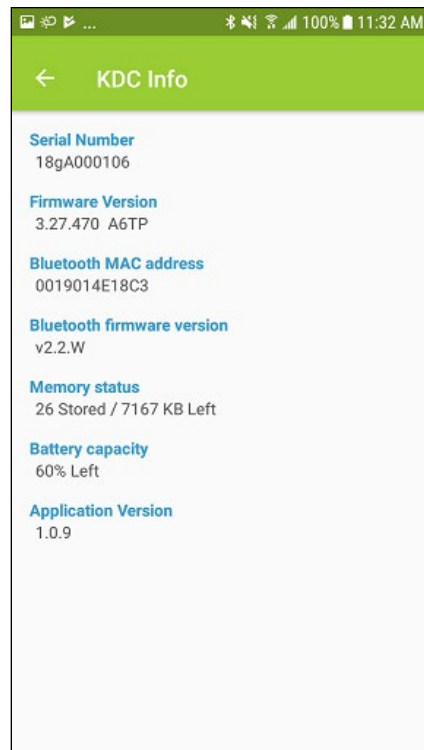

## 9. Product Specifications

### 9.1 Base Scanner

Physical	Design	Barcode SmartSled
	Size	KDC1000: 2.95" x 4.28" x 0.81" (75 x 108.6 x 20.7 mm) KDC1100: 2.95" x 4.28" x 1.06" (75 x 108.6 x 26.8 mm)
	Weight	KDC1000(w/o Battery): 2.68 oz (76 g) KDC1100(w/o Battery): 2.75 oz (78 g)
Functionality	Supporting OS	Android / iOS / Windows / Mac OS X
	Keys	2 SCAN(READ) Keys
	Buzzer	Yes
	LED Indicator	1 Status LED (Red / Amber / Green)
	USB Port	1 Type-C USB Port
Memory	RAM	SDRAM 256KB
	ROM	Program Flash ROM 1,024KB User Data Flash ROM 8MB
	Barcode/Rfid Storage	400,000+ Barcodes/Rfid tags (EAN-13 or EPC Data)
Power	Battery (Standard)	750 mAh Lithium-Ion(Optional)
	Extended Battery	2,000 mAh / 6,000 mAh (Optional)
	Charging Solution	USB Connector / Charging Cradle
	Simultaneous Charging	Yes
	Charging Time (KDC)	3 Hours
Communication	Bluetooth	Bluetooth Low Energy V5.0, HID/SPP
	USB	USB HID, USB Serial
	Serial	Serial (iPhone 13 & 14)
Barcode Reader	1D/2D Symbology	Yes
	# of scans (1 sec interval)	KDC1000C Imager: 26,500+ KDC1100H Imager: 31,000+
	# of scans (10 sec interval)	KDC1000C Imager: 11,000+ KDC1100H Imager: 20,000+
	Scan Range (20mil Code39)	KDC1000C Imager: 2.36" to 18.35" (60 to 466 mm) KDC1100S Laser: 1.40" to 52.00" (35 to 1320 mm) KDC1100H Imager: 1.73" to 31.5" (44 to 800 mm)
	Screen Reading	Yes
	Postal Code / OCR Passport	Yes / Yes (KDC1000C)
Companions	RFID (HF Reader)	Optional
	RFID (UHF Reader)	Optional (0.5W, 1.0W)
	Magnetic Strip Reader	Optional

See [Reference Manual](#) for more detailed information.

Visit [store.koamtac.com](https://store.koamtac.com) to purchase additional KDCs and accessories.

	Chip-and-PIN (EMV)	Optional
	Ext. Battery (2,000 mAh)	Optional
	Pistol Grip (6000 mAh)	Optional
Environment	Drop Spec	5 ft (1.5 m)
	IP Rating	IP65
	Operating Temp.	-4 °F ~ 122 °F (-20 °C ~ 50 °C)
	Storage Temp.	-4 °F ~ 140 °F (-20 °C ~ 60 °C)
	Humidity Spec	5% ~ 95% (non-condensing)
Regulatory Conformance	Laser Safety	IEC60825-1 (Class II) (KDC1100S/H)
	LED Safety	IEC62471:2006 (KDC1000C)
	Regulatory	CE, FCC, KC, J-MIC, VCCI, SRRC, RoHS Compliant
Accessories	Hand Strap	Yes
	1-slot Charging Cradle	Yes
	5-slot Charging Cradle	Yes
	Supporting Case	All Cases

### 9.2 1.0W UHF Reader

Physical	Design	Pistol Grip UHF Reader
	Weight (w/o KDC)	15.0 oz (425 g)
RFID Details	Supported Standards	EPC Class1 Gen2, EPC Gen2 V2
	Nominal Read Range	20'+ (6m+) dependent on tag type and operating environment
	Output Power Range	+0 to +30 dBm
	Tag Read Rate / Storage	400+ tags per second / 400,000+ Barcodes/RFID tags (EAN-13 or EPC Data)

### 9.3 0.5W UHF Reader

Physical	Design	Handheld UHF Reader
	Weight (w/o KDC)	1.9 oz (53 g)
RFID Details	Supported Standards	EPC Class1 Gen2, EPC Gen2 V2
	Nominal Read Range	5'+ (1.5m+) dependent on tag type and operating environment
	Output Power Range	+0 to +27 dBm
	Tag Read Rate / Storage	100+ tags per second / 400,000+ Barcodes/RFID tags (EAN-13 or EPC Data)

### 10. Appendix. Useful Special Barcodes

#### 10.1 Scan Options





#### 10.2 Scan Options



#### 10.3 Data Process - Wedge/Store, Enter Key & Extend Key



### 10.4 Data Process – Data Edit

<p>Start Prefix Enter</p>  <p>‡MKDC83000.</p>	<p>Start Suffix Enter</p>  <p>‡MKDC83001.</p>
<p>Finish Prefix / Suffix Enter</p>  <p>‡MKDC83002.</p>	<p>Cancel Prefix / Suffix Enter</p>  <p>‡MKDC83003.</p>



### 10.5 Data Process – Data Format and Handshake

<p>Data format = Barcode only</p>  <p>‡MKDC84001.</p>	<p>Data format = Packet data</p>  <p>‡MKDC84010.</p>
--	--

### 10.6 Data Process – Termination Character & Duplicate Check

<p>Termination Character = None</p>  <p>‡MKDC88000.</p>	<p>Termination Character = CR</p>  <p>‡MKDC88001.</p>
<p>Termination Character = LF</p>  <p>‡MKDC88002.</p>	<p>Termination Character = CR+LF</p>  <p>‡MKDC88003.</p>
<p>Termination Character = Tab</p>  <p>‡MKDC88004.</p>	

See [Reference Manual](#) for more detailed information.  
 Visit [store.koamtac.com](http://store.koamtac.com) to purchase additional KDCs and accessories.

<p>Enable Duplicate Check</p>  <p>┆MKDC89001.</p>	<p>Disable Duplicate Check</p>  <p>┆MKDC89010.</p>
--	--

### 10.7 Bluetooth

<p>Enable Bluetooth Power</p>  <p>┆MKDC60001.</p>	<p>Disable Bluetooth Power</p>  <p>┆MKDC60010.</p>
<p>Enter Pairing Mode</p>  <p>┆MKDC61001.</p>	<p>Disconnect</p>  <p>┆MKDC6D000.</p>
<p>Bluetooth Profile = SPP</p>  <p>┆MKDC6A000.</p>	<p>Bluetooth Profile = HID iOS</p>  <p>┆MKDC6A001.</p>
<p>Bluetooth Profile = MFi</p>  <p>┆MKDC6A002.</p>	<p>Bluetooth Profile = HID Normal</p>  <p>┆MKDC6A004.</p>

### 10.8 HID Initial Delay

<p>HID Initial Delay = Disabled</p>  <p>┆MKDCH0000.</p>	<p>HID Initial Delay = 1second</p>  <p>┆MKDCH0001.</p>
--	--

<p>HID Initial Delay = 2seconds</p>  <p>‡MKDCH0002.</p>	<p>HID Initial Delay = 3seconds</p>  <p>‡MKDCH0003.</p>
<p>HID Initial Delay = 5seconds</p>  <p>‡MKDCH0005.</p>	<p>HID Initial Delay = 10seconds</p>  <p>‡MKDCH000A.</p>

### 10.9 HID Character Delay

<p>HID Character Delay = Disabled</p>  <p>‡MKDCH1000.</p>	<p>HID Character Delay = 10msec</p>  <p>‡MKDCH100A.</p>
<p>HID Character Delay = 20msec</p>  <p>‡MKDCH1014.</p>	<p>HID Character Delay = 30msec</p>  <p>‡MKDCH101E.</p>
<p>HID Character Delay = 50msec</p>  <p>‡MKDCH1032.</p>	<p>HID Character Delay = 100msec</p>  <p>‡MKDCH1064.</p>

### 10.10 System

<p>Memory Status</p>  <p>‡MKDC50001.</p>	<p>Reset Memory</p>  <p>‡MKDC50002.</p>
---	---

<p>Reset BT Registry</p>  <p>┆MKDC50005.</p>	<p>Display Version</p>  <p>┆MKDC54001.</p>
<p>Factory Default</p>  <p>┆MKDC57001.</p>	<p>KDC Reset</p>  <p>┆MKDCA0000.</p>

## 10.11 OTG/Bluetooth (Android & iPhone15)

<p>USB OTG Mode</p>  <p>┆MKDC5h002.</p>	<p>Bluetooth Mode</p>  <p>┆MKDC5h001.</p>
---	--

KOAMTAC devices and accessories are not designed or intended to prevent, mitigate, treat, diagnose, or cure any disease or health condition, including COVID-19/Coronavirus. KOAMTAC devices and accessories are intended for general public use only.

KOAMTAC devices and accessories are not medical devices and are not intended for use in any medical or inherently infectious setting, or where exposure to bodily or hazardous fluids may be expected, or where the risk of exposure through inhalation is high.

KOAMTAC DEVICES ARE PROVIDED AS-IS WITH ALL FAULTS, AND KOAMTAC SPECIFICALLY DISCLAIMS ALL WARRANTIES, EXPRESS OR IMPLIED, INCLUDING (WITHOUT LIMITATION) IMPLIED WARRANTIES OF MERCHANTABILITY OR FITNESS FOR A PARTICULAR PURPOSE. KOAMTAC SPECIFICALLY DISCLAIMS THAT KOAMTAC DEVICES WILL PREVENT INFECTION OR THE TRANSMISSION OF VIRUSES OR DISEASES. KOAMTAC DEVICES ARE NOT A SUBSTITUTE FOR PROFESSIONAL MEDICAL ADVICE, DIAGNOSIS, OR TREATMENT, AND ANY MEDICAL QUESTIONS SHOULD BE DIRECTED TO YOUR HEALTHCARE PROVIDER. THE ENTIRE RISK AS TO THE QUALITY AND PERFORMANCE OF THE SOCIAL DISTANCING FEATURE OF THE PRODUCT IS WITH THE BUYER. SHOULD THE QUALITY OR PERFORMANCE OF THE SOCIAL DISTANCING FEATURE OF ANY KOAMTAC PRODUCTS PROVE DEFICIENT FOLLOWING ITS PURCHASE, THE BUYER ALONE, AND NOT THE MANUFACTURER, DISTRIBUTOR, OR RETAILER ASSUMES THE RISK OF ANY INFECTION OR DISEASE TRANSMISSION THAT MAY RESULT DURING BUYER USAGE. KOAMTAC ASSUMES NO LIABILITY FOR INACCURACIES OR MISSTATEMENTS BY THIRD-PARTY SELLERS.